

邀请您与我们一起发展

SINCERELY INVITE YOU DEVELOP WITH US

SINCE 1996

Since 1996



INTRODUCTION

Huasheng Industry registered name Heze Huasheng Wooden Co.,Ltd, locates in middle of China, Heze City Shandong Province, which is not far from Qingdao sea port. The company was established in 1996 by Mr. Fasheng Che. It has an area of 350,000 square meters in all, building area of 120,000 square meters, purified workshop of 100,000 square meters, specializes in manufacturing plantation shutter, venetian blinds and shade. The capital assets of the company is US\$28,500,000, and production capacity is US\$86,000,000 per year.

There are about 1200 workers, more than 400 machines, 68 PVC extrusion line, 16 painting line, separate laboratory room, strong R&D team and design team, professional production and sales team, fast delivery, 24 hours customer service team. Adopting advanced equipment with techniques. Our high quality products are strictly tested before being put into the market, it make us to be the leading supplier in window covering industry.

The company pay high attention to 7S management system, environmental protection, safety production and humanity. More and more experienced workers keep work here. The company passed ISO9001, Sedex, RoHS, FSC certificates for our products and gained more than 50 country patents .

We sincerely hold the tenet of "quality first, customers supreme" in mind when conducting business, ensuring the stable quality and maintaining the competitiveness of our customers, co-development with customers and all staff members' benefits.

If you want to know more about us, please find us in the following ways:

Company Website

www.huashengindustry.com

Product Website

Shutter: www.shutter-suppliers.com

Blinds: www.blinds-supplier.com

Shade: www.shadesupplier.com

Enda: www.shuttercomponentsupplier.com

Social media

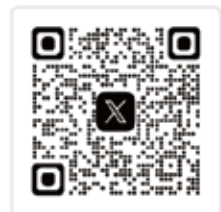

B2B

Name: Heze Huasheng Wooden Co., Ltd.

<https://sdhuasheng.en.alibaba.com/>

Sales Team

Mobile: 15806997933

Email: admin@huashengindustry.com

Postal Code: 274400

Address: NO.8 INDUSTRY ZONE ZHUANGZHAI TOWN HEZE CITY SHANDONG PROVINCE,CHINA



CONTENTS

Company Overview

P1-15

Venetian Blinds

P16-27

Plantation Shutter

P28-54

Shade Products

P55-60



INTRODUCTION

There are paulownia trees at home, attracting golden phoenix.

From an old proverb

Heze city is the hometown of Paulownia wood trees .



Founder - Mr. Fasheng Che

Rich experience on paulownia wood from 1994. He is the first batch producer of wood products, manufacture paulownia wood furniture board and moulding.

Strategic long-term perspective. He insists paulownia wood is the best wood. He takes the market and customer demand as the guidance, starts produce paulownia wood blinds and shutters, makes the company to be the local leading enterprise within 20 years.

CEO - Mr. Debiao Che

Founded wooden board import and export trading company in Qingdao city. Benefit from it, he has penetrating insight of the international market and broader horizons, lead the company extrude PVC shutter and blinds components, build Huasheng hotel, promote 7S in the production process and stock management system, lead the company to a higher level.



GM - Mr. Lubiao Che

Study in United States, MBA

Worked in Louge Shutter- China market

Manage Huasheng Antai Hospital



Huasheng New Town Hotel



Huasheng Antai Hospital

Location : Middle of China



★ Airport: Zhengzhou airport / Heze Mudan Airport

★ High-speed Rail Station: Lankao South Station / Zhuangzhai Station / Heze East Station



Air & Express delivery
7-10 days



Train Delivery
Zhengzhou Station
18 days to Hamburg



Sea Delivery
Qingdao Sea Port

Our Historical Development

2006



Start produce paulownia wood slats for Taiwan ABC Blinds.

2007



Produce ready made paulownia wood blinds, it is an important milestone for Huasheng Industry.

2009



Start produce paulownia wood plantation shutters.

2010



The first Exhibition for Huasheng Industry.

The Predecessor of Huasheng Industry Founded, produce paulownia wood finger joint furniture board.



1996

Huasheng Industry registered name Heze Huasheng Wooden Co.,Ltd.



Original Appearance of Workshop

2002

Produce Paulownia wood Moulding for US market, the first factory to produce seal coated paulownia wood products in China.



2004

Acquired Yingchun Wooden factory. It reserve a large number talents for further development on shutters and blinds.



2005

Our Historical Development

2019



Extrude PVC Blinds components and make finished blinds.

2020



4th Shutter workshop ready for production, capacity 2000sqm per day.

2022



Expand PVC venetian blinds program. Structural reform and redecorate Huasheng Hotel. New dormitory for workers.

2023



Huasheng Antai hospital open. Huasheng Industry continues to develop.

2014



Acquired Jinmu Wood factory, start extrude PVC shutter components.

2015



Acquired Yili Wood factory, build 2nd shutter workshop. Capacity from 5,000sqm to 10,000 sqm each month.

2016



Build Huasheng Hotel, and employee dormitory, supply apartment for company senior manager.

2017



Expand MTM shutter program, the 3rd shutter workshop was put into production.

INTRODUCTION



Wooden Blinds Workshop

Fauxwood Blinds Workshop

Wooden Shutter Components Workshop

PVC Shutter Components Workshop

Shutter Workshop

It covers an area of 350,000 square meters.

ENVIRONMENTAL PROTECTION

Invest much money to purchase Photooxygen equipment, Dust-re-moving equipment, burning natural gas instead of coal and so on.



SAFETY PRODUCTION



7S MANAGEMENT SYSTEM



Production Process Standardization
More Clean and Clarity of the Work Environment
Improve Production Efficiency and product quality



HUMANITY



OUR INVENTORY



3000CBM / monthly



5000CBM / monthly



1000CBM / monthly



1500CBM / monthly



500 tons



1500CBM / monthly



5000CBM / monthly



Warehouse Management System

CERTIFICATE



R&D



RESEARCH

It's driven by our commitment to customers on quality, safety, improvement on products, and the market demand. Through our continuous improvement, our aim is to supply more and better solutions to our customers, and help them to be more competitive with unique characteristics.

INNOVATE

We are open for any new idea and new products, pleased to develop together with you. The purposes and philosophy of Our company: Bold Innovation, Cooperation and Win-Win.



QUALITY CONTROL



DESIGN

The Design Team is a systematic innovation activity centered on customers and strategically solving problems. It is the starting point of the innovation chain, help enterprises overcome the shortcomings in our previous business processes, design and organize various parts of the product more reasonably, greatly enhancing market competitiveness and provide better service to customers.



LABORATORY

We have special experimental machines for product testing to ensure that any aspect of our products can meet your needs, we work tirelessly to ensure that every detail is impeccable.

LABORATORY MACHINE



Constant Temperature and Humidity Chambers



QUV-vis Spectrometer



Xenon Test



Strain Relief Test



Pencil Hardness Test



Cross-Cut Tester



Light Box



Colorimeter



QUALITY CONTROL

We sincerely hold the tenet of "quality first, customers supreme" in mind when conducting business, our QC keep check quality in every production process .

PATENT



We attach great importance to R&D and patent registration, with more than 50 country patents, like hidden tilt rod , easy lift blind, Induction-controlled ventilation blinds, rack system fixed shutter, cushioning properties shutter wheels ,and so on.

OUR TEAM



OVERSEAS MARKETING TEAM

Focus on provide solutions to customers
 Help hundreds companies start shutter and blinds business, some dealers to be leading wholesalers
 The whole team with the most sincerity invite you to create both-win business in window covering industry.



MANAGER

15 years international business experience.
 Keen market insight
 Courage to explore and innovate
 Excellent communication skills
 Annual sales from US\$11,500,000 per year to US\$71,500,000 within 12 years

If you do what you like to do, you'll do better.

SALES TEAM



8 years experience
 Fast delivery
 In time documents



SHIPPING TEAM

7&24 customer service online

CUSTOMER SERVICE TEAM



EXHIBITION



VENETIAN BLINDS

2006



Venetian Blinds

MATERIAL



Paulownia Blinds

Paulownia wood is real natural wood with beautiful grain, stable rich resource, light weight to save motor power.

Basswood Blinds

Basswood is the traditional history hard wood and well know by people in the world.

Bamboo Blinds

Bamboo is environmentally friendly, sustainable and recycled material for window treatments.

Fauxwood Blinds

Faux wood blinds is a good choice for moisture resistance, affordability, durable, easy maintenance and durability.



★ More information interested, please visit our blinds website: www.blinds-supplier.com

PRODUCT

READY MADE BLINDS



Ready made blinds are mass produced blinds that come with a small range but popular sizes, which normal sell in shops, malls and supermarkets. The buyers can mount the blinds to the window directly themselves after buying to home.



CUT-DOWN BLINDS



Cut down blinds are mass produced blinds with ladders left to fixed length, customers can cut the width from the ends and restring the slats to request height of the blinds for custom made sizes in their own factories or facilities with one cut down machine.



PRODUCT

MADE TO MEASURE BLINDS

Material: Wooden and Faux wood
 System: Traditional/ Chain Mechanism/ Motorised
 Slats size: 50mm and 63mm
 Color: 26 colors of wooden, 5 colors of faux wood
 Blinds width: 300mm-3000mm
 MOQ: 1 pc
 Leading time: 3-7 days
 Packing: Standard mail order packing



BLINDS COMPONENTS



★ ★ ★ Blinds Accessories are available be bought together slats/valance/bottom rail.

SYSTEM

TRADITIONAL BLINDS



Min. width/height: 40cm
Max. width/height: 260cm



CHAIN MACHANISM BLINDS

Min. width/height: 47cm
Max. width/height: 300cm



SYSTEM

CORDLESS BLINDS



Min. width/height: 55cm
Max. width/height: 180cm



MOTORISED BLINDS

Min. width/height: 62cm
Max. width/height: 300cm



SYSTEM

EASY FIT BLINDS



Slats size: 25mm

You just need to connect the blinds into frames and install directly to the window with brackets at your local, not need screws.



SHUTTER BLINDS PLUS



Slats size: 25mm /50mm /63mm

The shutter blinds plus is a affordability window treatment which looks same as plantation shutters when people stand out of the window.

Q: I want to have shutter style window covering, but cost higher. How can i do?

A: Choose shutter blinds plus.

PRODUCTION PROCESS - WOODEN

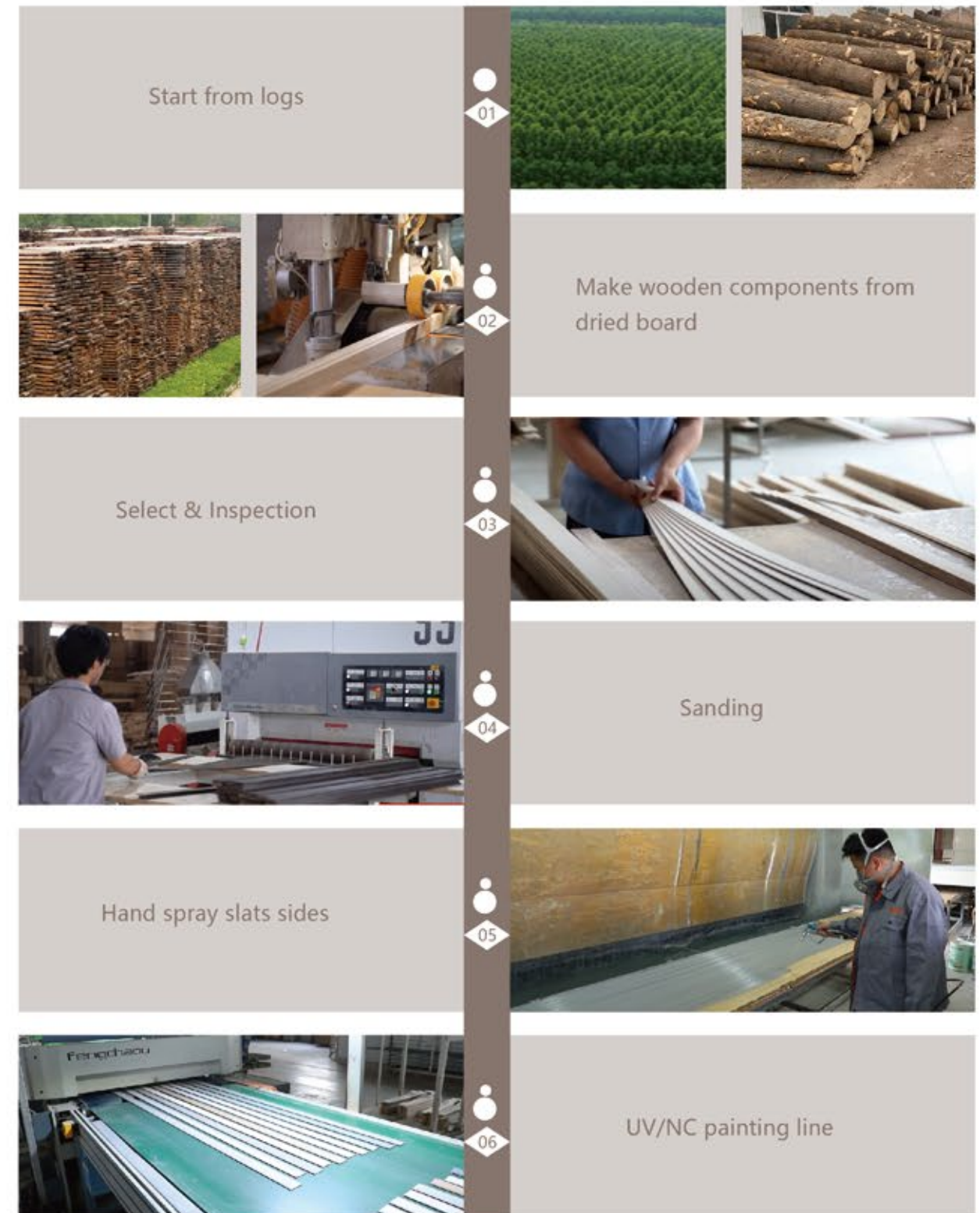

PRODUCTION PROCESS - WOODEN

07 Colors pick up/Inspection



08 Cutting Length



09 Punching holes of components



10 Assemble



11 Inspection



12 Packing



PRODUCTION PROCESS - FAUX WOOD

01 Raw color material mixing



02 Faux wood profile extrusion lines



03 QC Inspection



04 Blinds assemble



05 Blinds inspection



06 Packing



INSTALLATION CASE



Living Room



Bathroom



Living Room



Dining Room



Kitchen

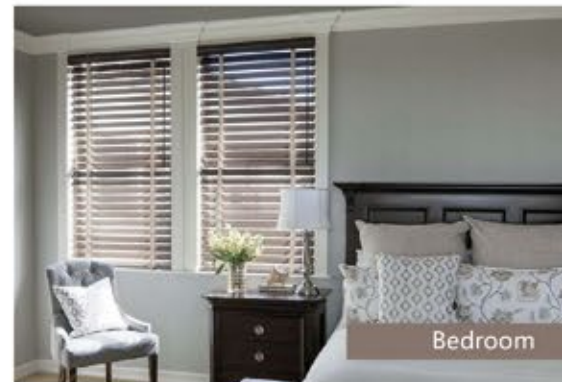

Bedroom

PLANTATION SHUTTER

2009

For more information ask our sales team for the Blinds technical manual.



Plantation Shutter

MATERIAL



Wooden shutter

Wooden shutter offers inimitable flexibility when it comes to designing and styling. Wooden shutters can be sanded, painted and stained to any colour of choice.

PVC shutter

PVC has for long been the preferred shutter material for many households. PVC is the best option if you are looking for a shutter material that is resistant to moisture and heat.

Aluminium shutter

Aluminium is one of the most popular construction materials today. Aluminium shutters are strong and lightweight, fireproof, waterproof, anti-theft.

Shutter Display

★ More information interested, please visit our shutter website: www.huashengindustry.com

| SHUTTER COLOR

Painted Color



Stained Color

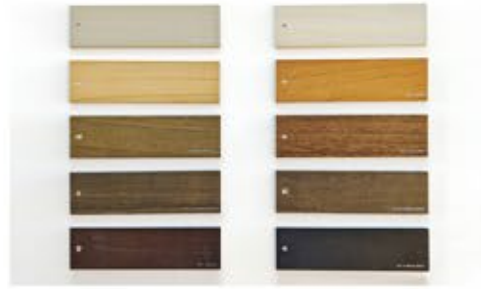

Brushed Color



Open Finish Color



| SHUTTER COLOR

Aluminium Color



Customized Color



Embrace Your Individuality

All you need to do is send us the color card you need, or choose from the international color card books: Dulux, RAL, Little Greene, Farrow&Ball, etc. We match the color of your choice and send it to you for approval. We offer customized color shutter with no minimum order quantity.



SHUTTER TYPES



Full Height Shutters

A practical and elegant window treatment, full-height shutters help you keep your room cool when it's hot outside and warm when it's cold, as well as providing extra security, privacy and soundproofing.



Tier on Tier Shutters

Tier-on-tier window shutters give complete window coverage while letting you open the slats of the top and bottom halves independently. You can enjoy light and privacy in any combination you choose.

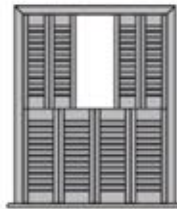

Cafe Style Shutters

Designed to cover only the lower half of your window, cafe style shutters are a stylish choice for any body who wants to prevent passersby from peering into your living spaces while still letting in plenty of light.



Track Shutters

Track shutters can be fitted to your space in one of two ways. With the by-pass system, panels glide past each other on their own tracks, whilst with the bi-fold, they simply fold out of the way.

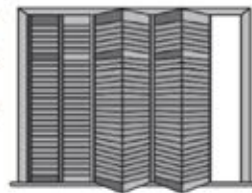

SHUTTER TYPES



Bay Shutters

Perfect bay window shutters make the most of the natural light and privacy. Window shutters maximise the space inside your room while adding a layer of insulation.



Special Shape Shutters

Whatever the peculiar shape of your window or doorway, we'll custom-make a hardwood shutter to fit. Arches, hexagons, circles, triangles, sunbursts, irregular angles - the list goes on.

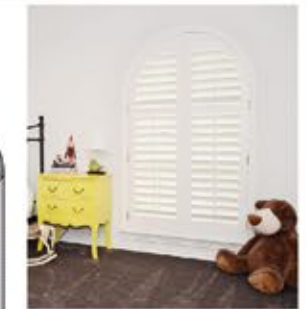

Additional Products



Shutter With Blackout Blinds

A blackout blinds can be ordered to fit behind our plantation shutters, allowing you to achieve total room darkness. Ideal for bedrooms, media rooms or nurseries. The honey-comb design completely blocks out the light with each cell having an internal foil wrap, creating both light block out and thermal insulation. The insulating characteristics help keep the heat out in summer and the warmth in during winter.

Shutter With Screen Shade

Screen Shade With Shutter is a special gauze mesh installed on the window, the main purpose of which is to prevent mosquitoes and other insects from entering the room, while maintaining ventilation.

Our R&D team will develop more products...



MOTORIZED SHUTTER



3 Louver Brackets



Stroke Calibration



Solar Panel



Chargng Cable And Charging Head

PRODUCTION PROCESS - WOODEN

01 Kiln dried edge glued paulownia board with moisture 8% below

02 Laminated board- The material will be straighter & stronger, not easy to bend, not easy to crack

03 Cut to be small board & four-side moulder

04 Seal coating & Automatic drying line

05 Machine sanding

06 UV primer

PRODUCTION PROCESS - WOODEN

Cut materials according to order and drawing 07 

08  Assemble shutter

09  Hand sanding panel and frame

10  Painting

11  QC final inspection before packaging and take photos for record

12  Package

PRODUCTION PROCESS - PVC

PVC shutter raw materials 01 

02  30 extrusion lines

03  150+ shutter profiles

04  QC checks shutter profiles size, etc

05  Pre-painted shutter profiles (for selling profiles only)

06  Cut materials according to order and drawing

PRODUCTION PROCESS - PVC

Assemble shutter	
	QC checks shutter components and dimensions according to orders and drawings
Painting	
	Hand sanding panel and frame
QC final inspection before packaging and take photos for record	
	Package

PRODUCTION PROCESS - ALUMINIUM

Purchase standard aluminum shutter profiles through production	
	Cut materials according to order and drawing
Powder coating	
	Assemble shutter
QC final inspection before packaging and take photos for record	
	Package

INSTALLATION CASE



Bedroom

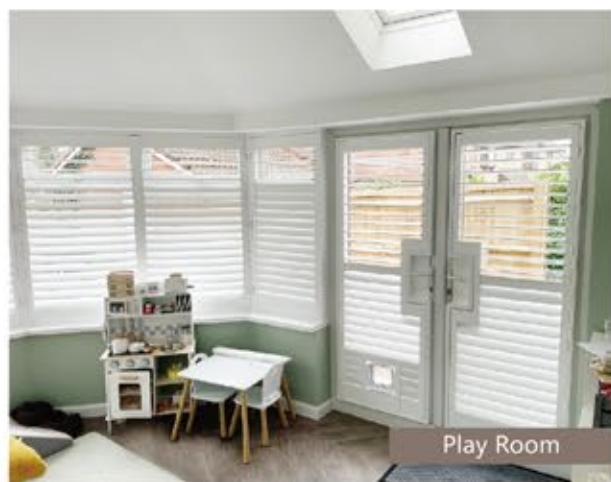

Play Room



Kitchen



Movie Room



Bathroom



Living Room

SHUTTER COMPONENTS

Louver

Wooden Louver

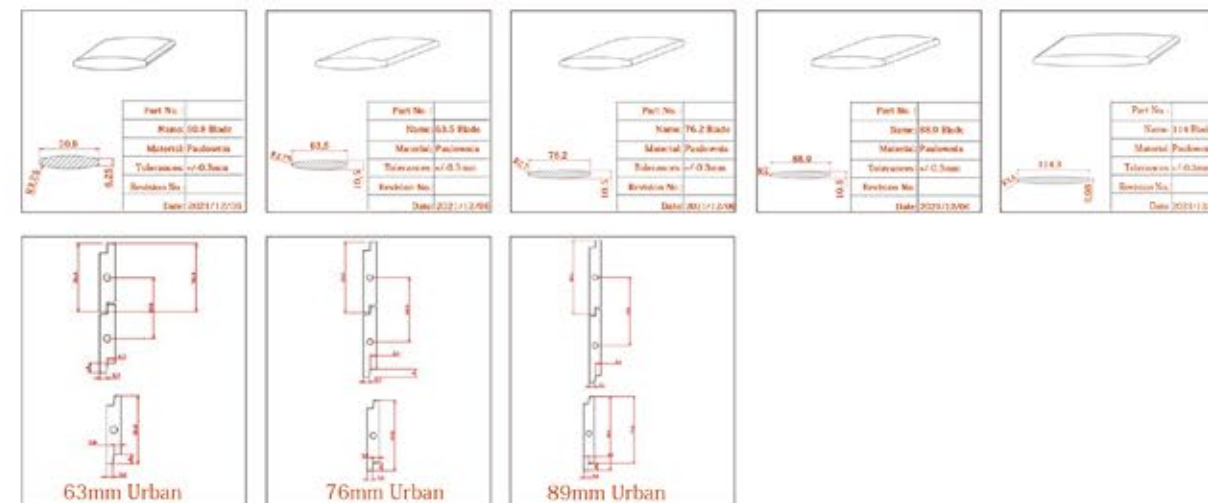

PVC Louver

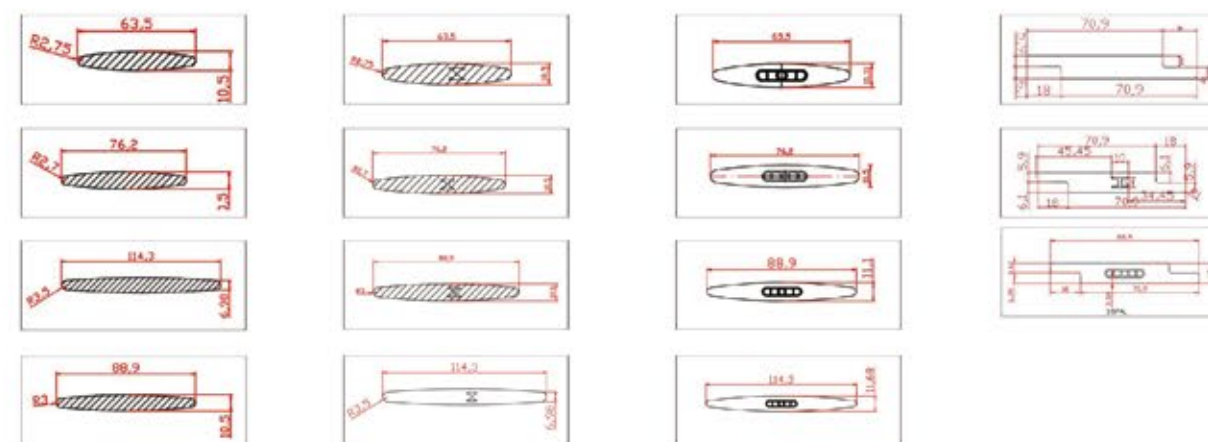







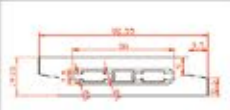

Stile

Wooden Stile

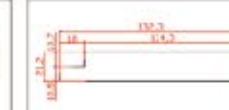

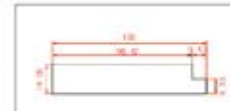
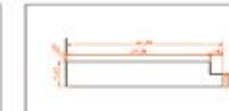

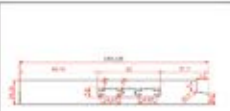







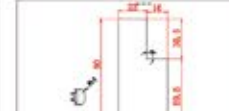

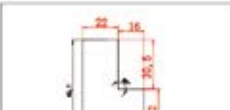

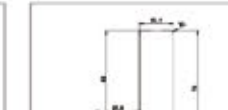

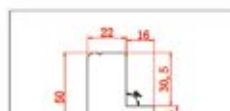
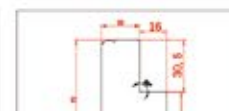











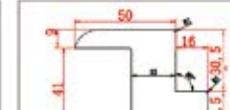
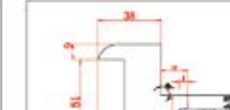

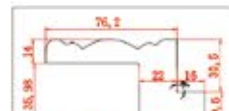

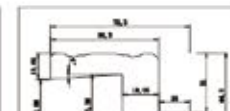
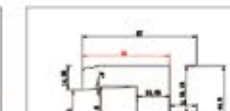

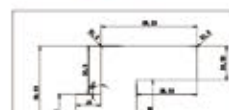

For more information ask our sales team for the Shutter technical manual.

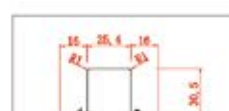
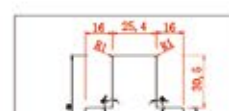
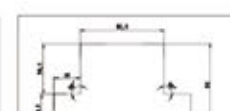
				
Part No. : 3/60RA Name: 3/4 reinforced mid rail Material: PVC Tolerances: +/-0.3mm	Part No. : 3/30 Name: 80mm Top/bottom rail Material: PVC Tolerances: +/-0.3mm	Part No. : 4/30 Name: 110mm Top/bottom rail Material: PVC Tolerances: +/-0.3mm	Part No. : 5/30 Name: 140mm Top/bottom rail Material: PVC Tolerances: +/-0.3mm	Part No. : 6/30 Name: 60mm mid rail for surface frame Material: PVC Tolerances: +/-0.3mm
				
Part No. : 8/30 Name: 170mm corner/edge/door Material: PVC Tolerances: +/-0.3mm	Part No. : 6/60 Name: 60 Rail Material: PVC Tolerances: +/-0.3mm	Part No. : 6/30 Name: 40 Rail Material: PVC Tolerances: +/-0.3mm	Part No. : 3/60 Name: 4 1/2" x 3/4" Rail Material: PVC Tolerances: +/-0.3mm	Part No. : 0/60A Name: 3/4 reinforced top & bottom rail Material: PVC Tolerances: +/-0.3mm
				
Part No. : 5/7/90A Name: 5.7/8" reinforced rail Material: PVC Tolerances: +/-0.3mm				

Frame

Wooden Frame

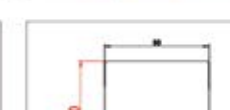
				
Part No. : 65/50R Name: 65 50mm end rail	Part No. : 65/50L Name: 65 50mm end rail	Part No. : 70/50 Name: 70mm end rail	Part No. : 90/8 Name: 90mm end rail	Part No. : 70/8 Name: 70mm end rail
				
Part No. : 62/70R Name: 62 70mm end rail	Part No. : 75/60 Name: 75 60mm end rail	Part No. : 90/8 Name: 90mm end rail	Part No. : 6/FRAME Name: 6 FRAME	Part No. : STANDARD Name: STANDARD
				
Part No. : 60/8 Name: 60mm end rail	Part No. : 5/8S Name: 5/8S	Part No. : 5/8S-70 Name: 5/8S-70	Part No. : 5/8S-90 Name: 5/8S-90	Part No. : 5/8S-62.7 Name: 5/8S-62.7

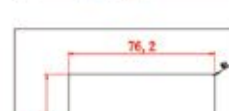
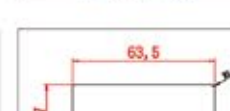
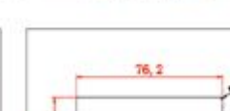
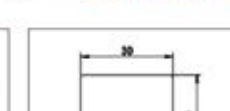
				
Part No. : 5/8S-75.4 Name: 5/8S-75.4	Part No. : 5/CS Name: 5/CS	Part No. : 5/8S-62.7-200 Name: 5/8S-62.7-200	Part No. : 7/50 Name: 7/50	Part No. : 7/50 Name: 7/50
				
Part No. : 7/90 Name: 7/90	Part No. : 240 Name: 240	Part No. : 230 Name: 230	Part No. : 240SP Name: 240SP	Part No. : 27 Name: 27
				
Part No. : 240/CS Name: 240/CS	Part No. : 22-85 Name: 22-85	Part No. : 1800-225-1 Name: 1800-225-1	Part No. : 27/80MM Name: 27/80MM	Part No. : 27/80MM Material: 27/80MM
				
Part No. : 1800-225-1 Name: 1800-225-1	Part No. : 27/8 Name: 27/8	Part No. : D-1.2 Name: D-1.2	Part No. : D-3 Name: D-3	Part No. : 1800-225-4 Name: 1800-225-4
				
Part No. : 27-POINT-50 Name: 27-POINT-50	Part No. : 27-POINT-60 Name: 27-POINT-60	Part No. : 27-50 Name: 27-50	Part No. : 80/87-POINT Name: 80/87-POINT	Part No. : 80/8 Name: 80/8
				
Part No. : 80/87-POINT Name: 80/87-POINT	Part No. : 50/38.1 Hang Strip Name: 50/38.1 Hang Strip	Part No. : 50/50 Hang Strip Name: 50/50 Hang Strip	Part No. : 50/50 Hang Strip Name: 50/50 Hang Strip	Part No. : 50/50.8 Hang Strip Name: 50/50.8 Hang Strip
				
Part No. : 50-63.5 Hang Strip Material: 50-63.5 Hang Strip	Part No. : 60/76.2 Hang Strip Name: 60/76.2 Hang Strip	Part No. : 27/63.5 Hang Strip Name: 27/63.5 Hang Strip	Part No. : 27/76.2 Hang Strip Name: 27/76.2 Hang Strip	Part No. : 30/27 Hang Strip Name: 30/27 Hang Strip

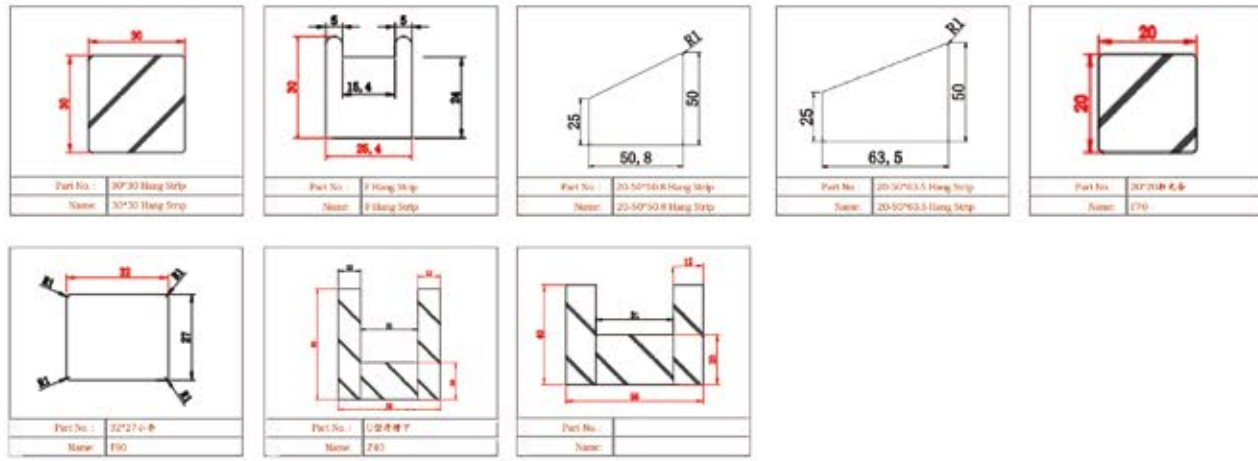

PVC Frame

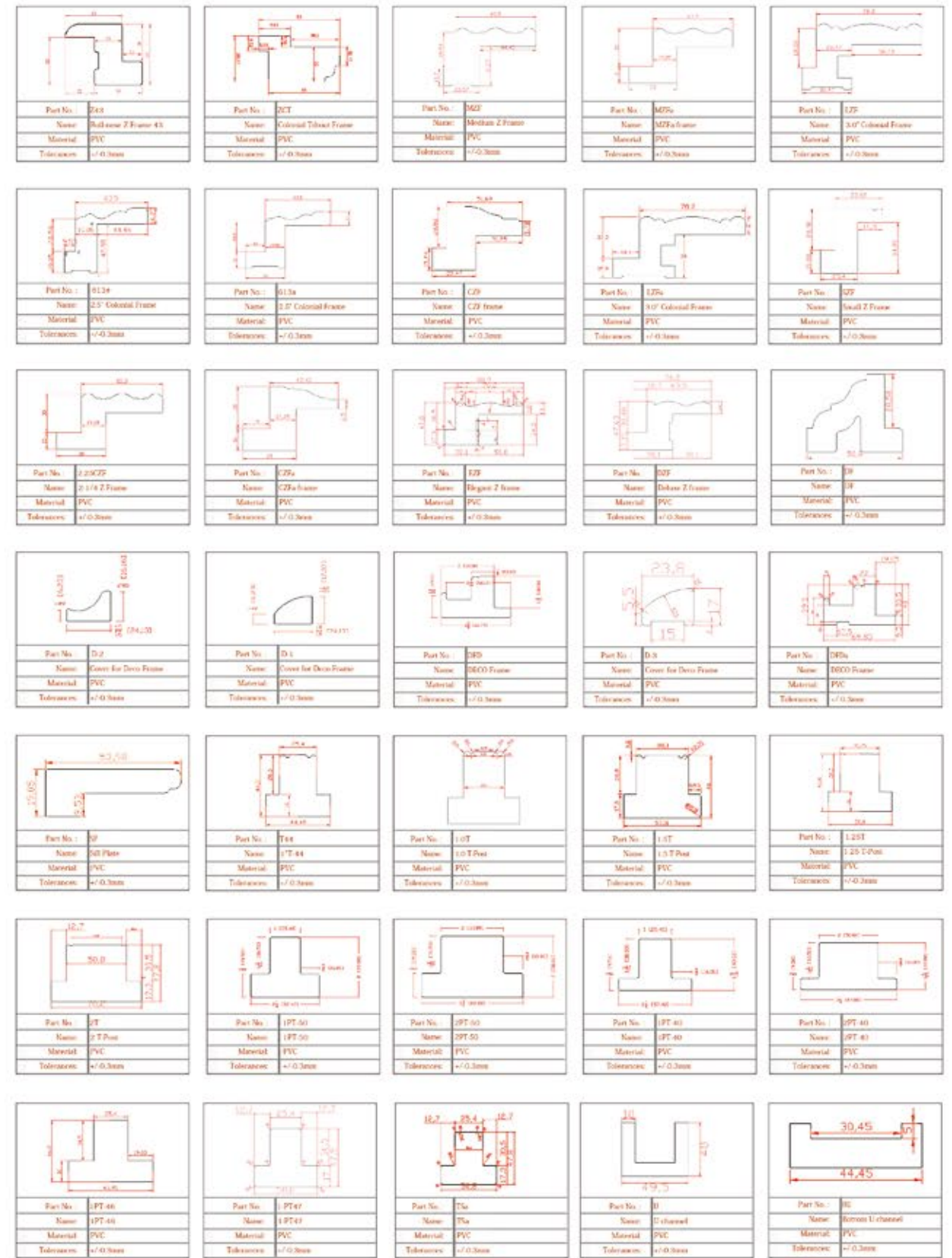

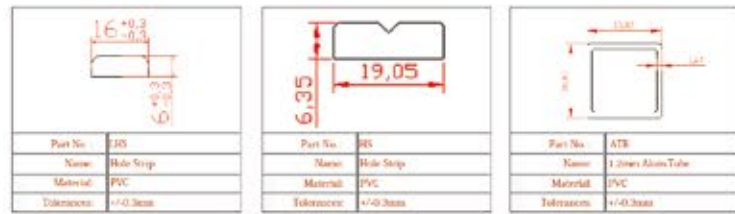
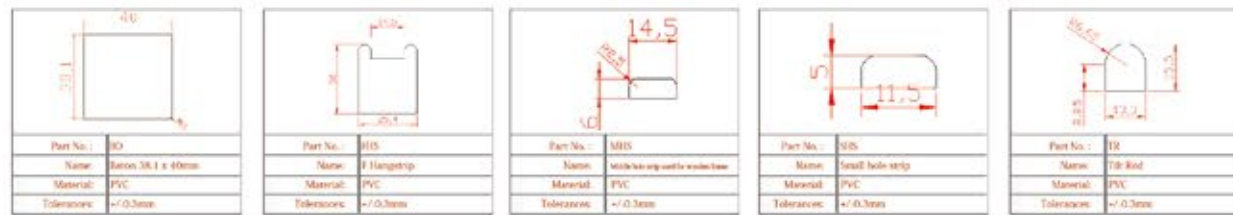
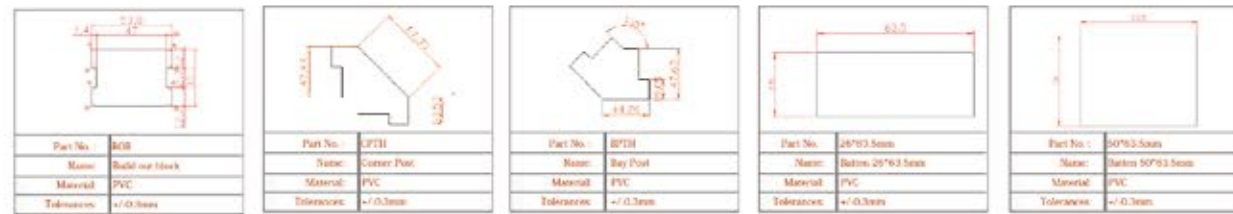
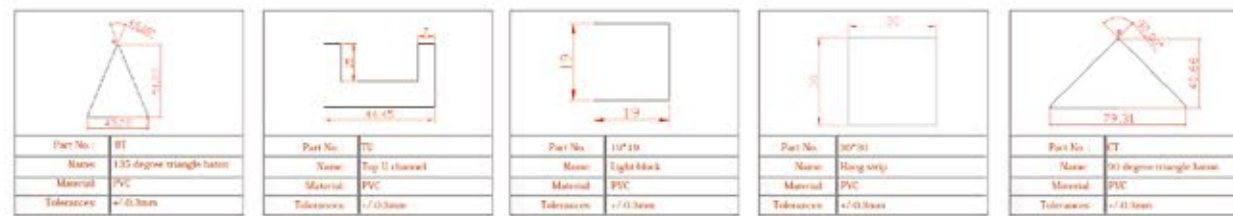

Wood Track System

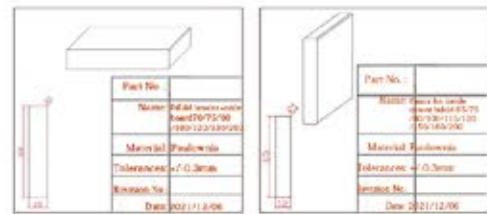

PVC Track System

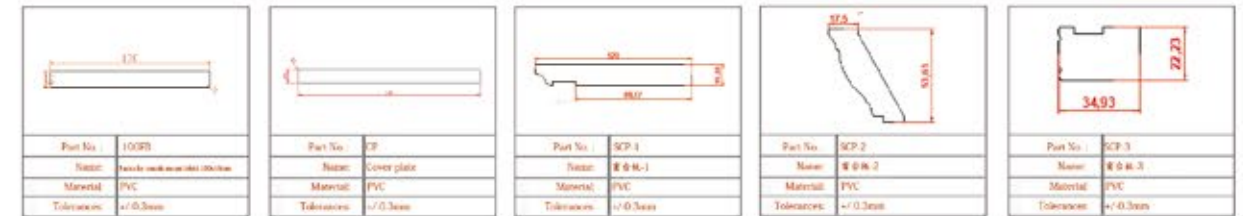

Aluminum Components

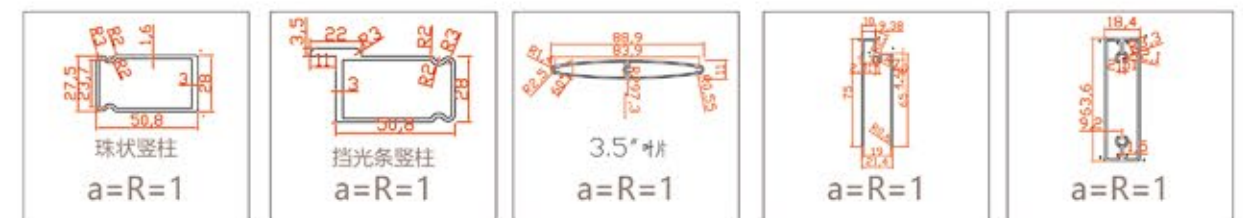
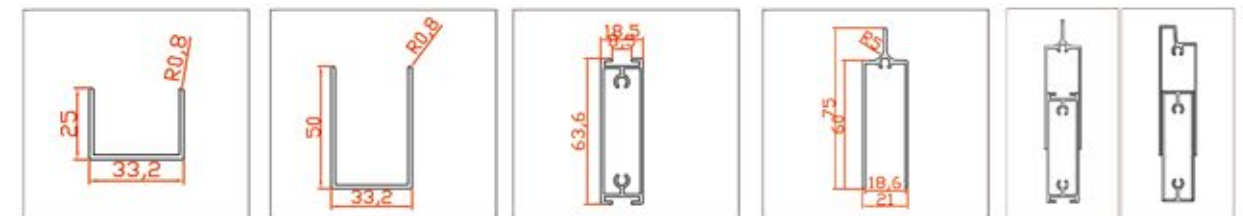
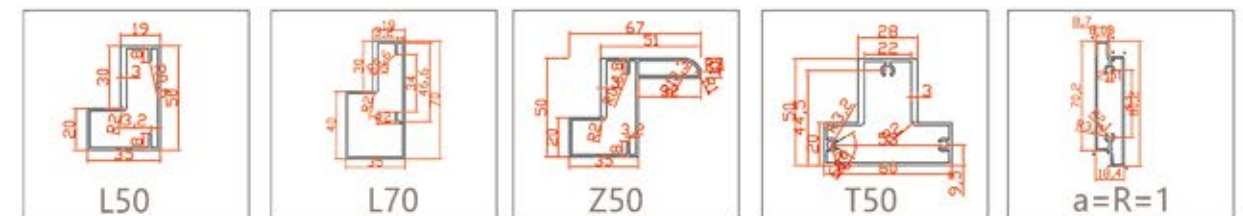

HARDWARE

Hinge



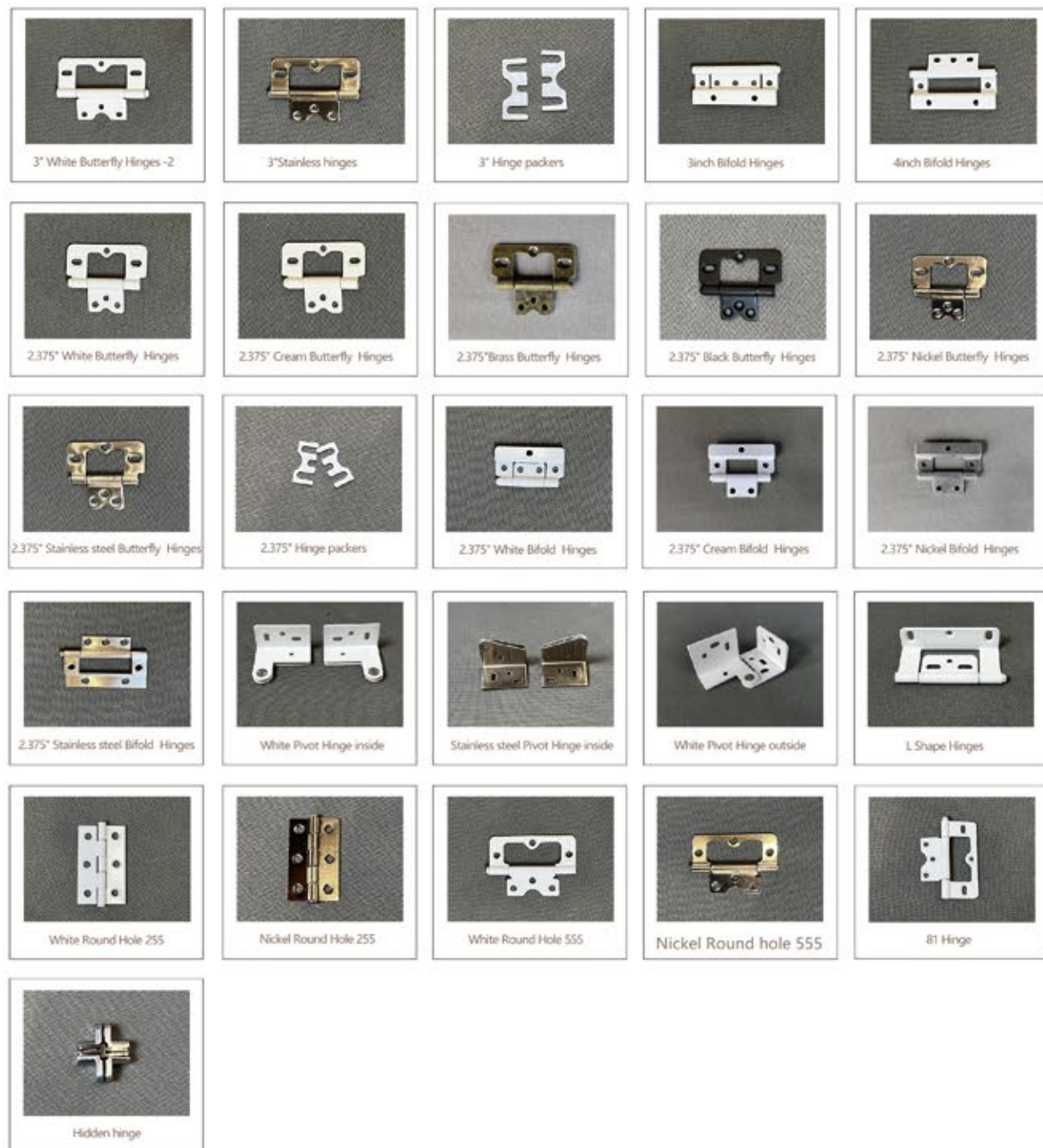

Magnet and Magnet Plate



Lock



Plastic accessories

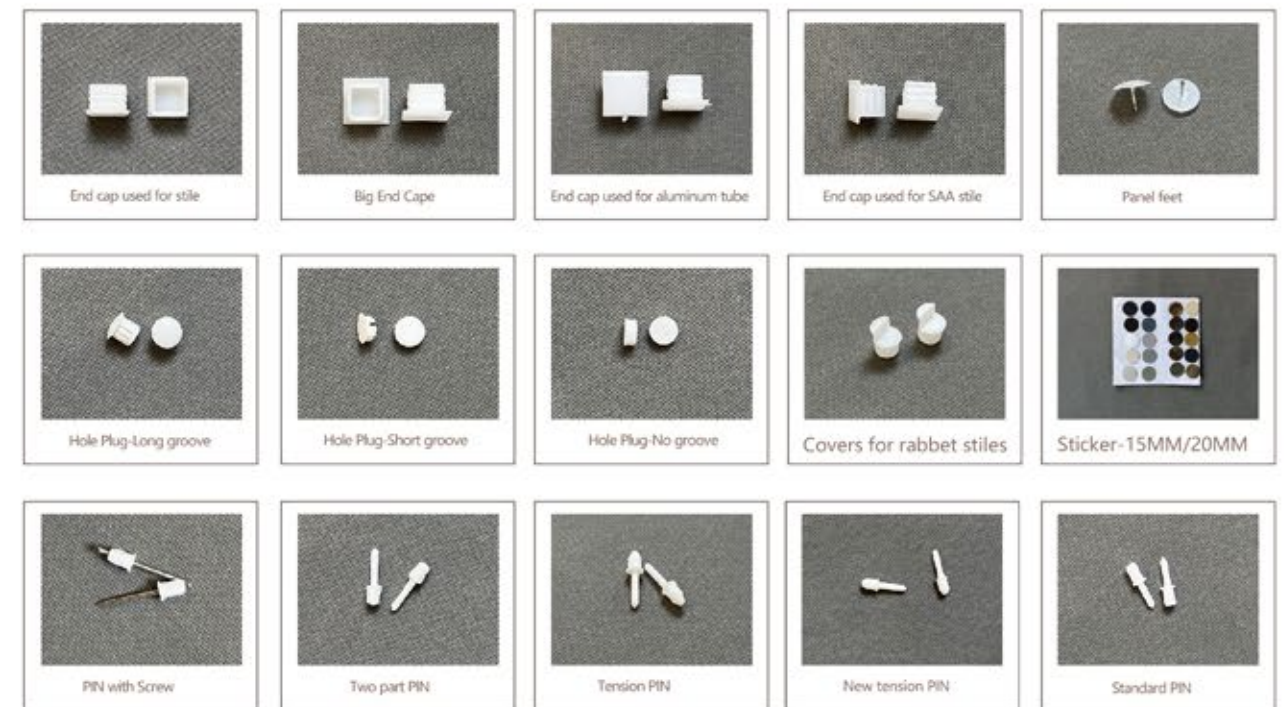

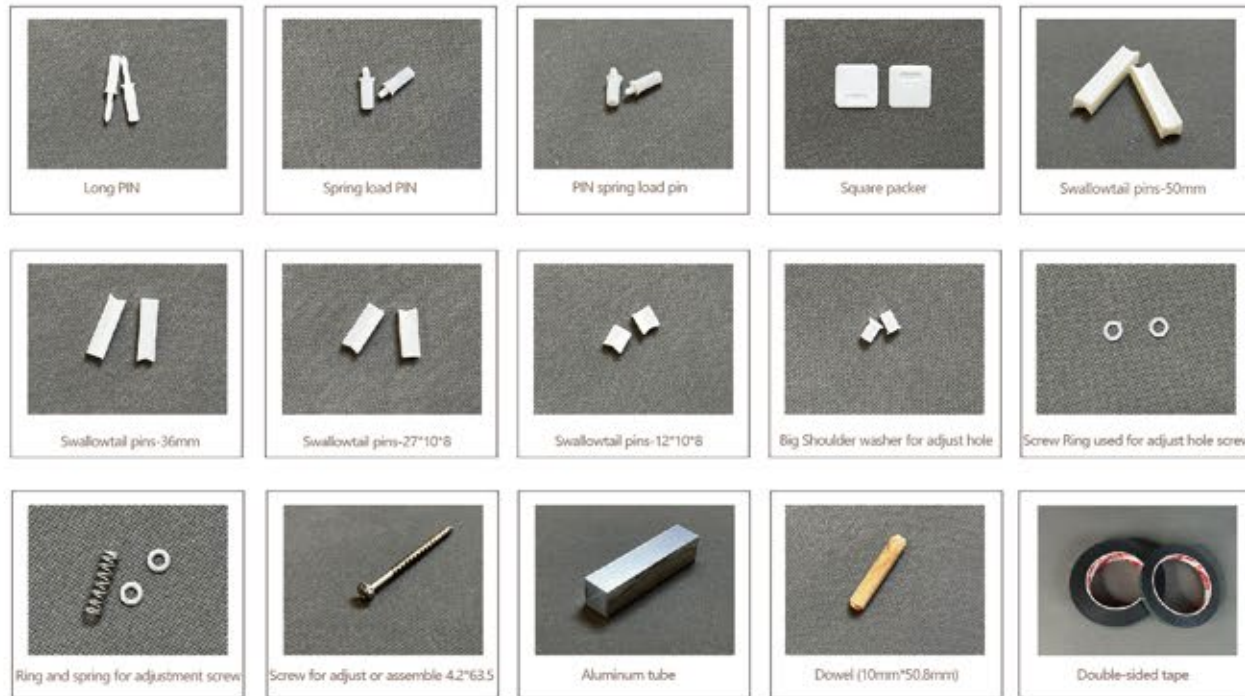

Tilt Rod

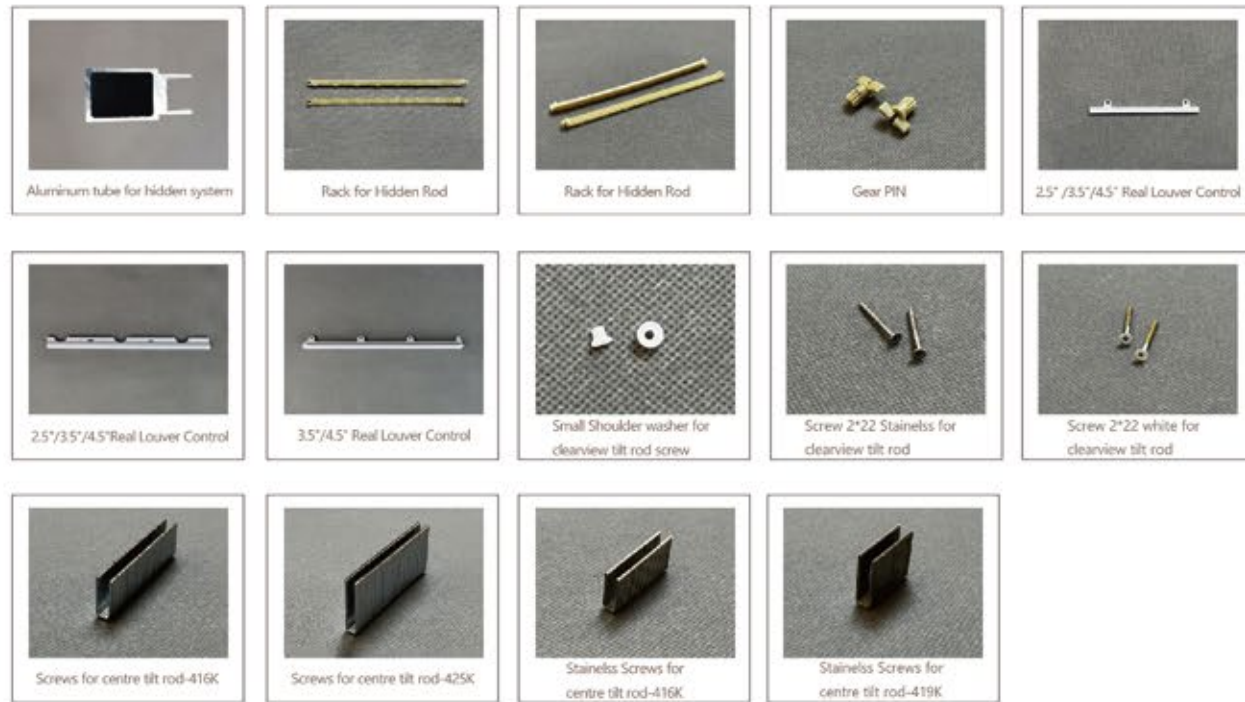

Track System

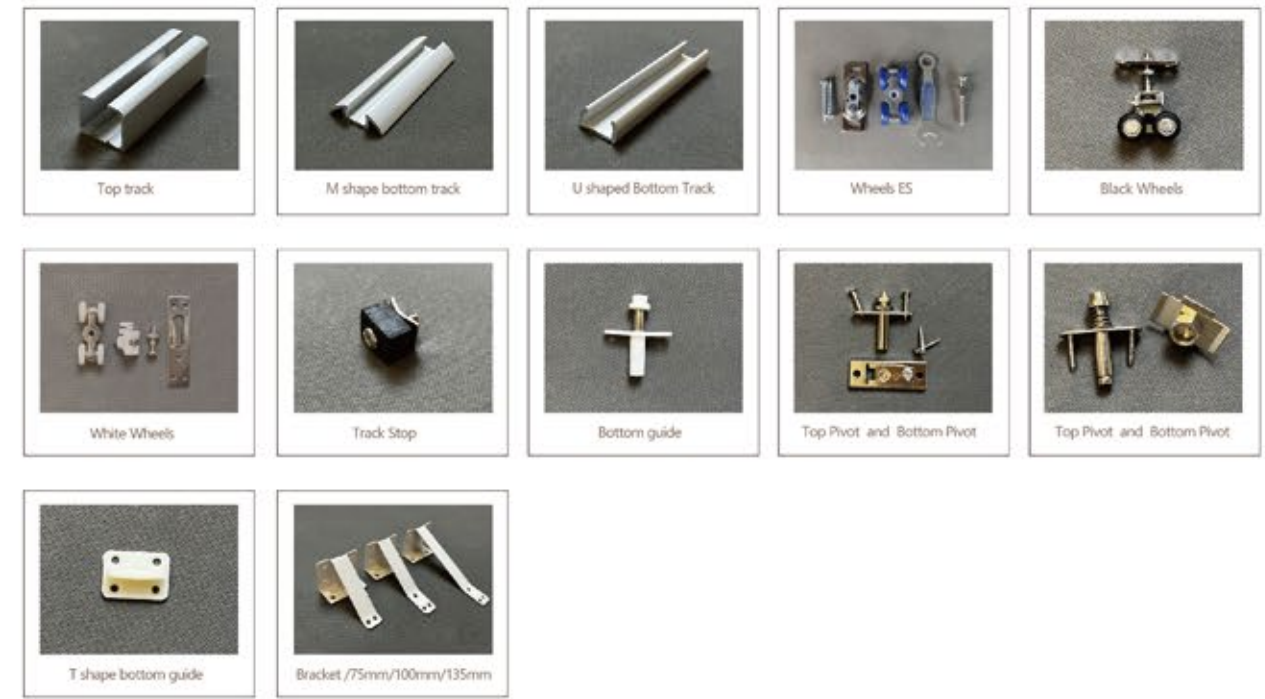

More



I can't find the part I need here. Can you match it?

Yes, we can make new mold for you.

SHADE PRODUCTS

2019



Shade

OEM/ODM Shade



- ★ Labor cost lower
- ★ Precise equipment
- ★ 20+ years experience in window decoration manufacture
- ★ Stable fabric and accessories supply chain
- ★ Maily supply for supermarket and B2C online store

Zebra Shade

Zebra shades provide greater control of switching between sheer and privacy with double layered fabrics.

Roller Shade

Roller shade have been a common choice among homeowners due to their convenience and versatility.

Pleated Shade

Pleated shade combine the advantages of a traditional shade with a modern design that features crisp, even pleats.

Roman Shade

Roman Shade is an attractive, durable window treatment with energy-efficient properties.

Honeycomb Shade

Honeycomb shade contemporary style with clean lines. And high-performance design allow the shades to instantly elevate any room.

Roller Shade

Color & Fabric & System



Spring System Roller Shade



Zebra Shade



QC

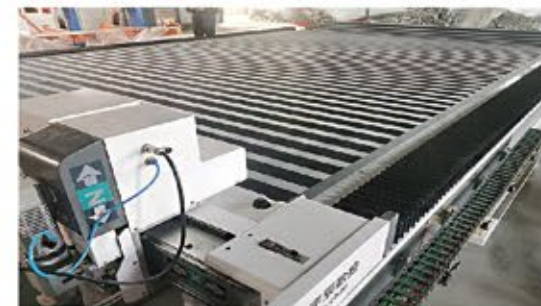

Laser Cloth Cutting Machine



Cordless Zebra Shade

Honeycomb Shade

Color & Fabric & System



Roman Shade

Color & Fabric & System



Pleated Shade



Huasheng Industry has been committed to achieving China's precision manufacturing of window decoration products worldwide for many years. We are centered around a first-class team. Design and manufacture first-rate products. We also have a professional customer service team to serve high-quality customers.

Huasheng Industry has always been in an open state. If you have any new projects in the window decoration category, welcome to find us and jointly create new window decoration products that belong to us.

Let's work together for mutual benefit and growth.