

百叶帘技术手册

Venetian blinds Technical Manual

华升实业
HUASHENG INDUSTRY



目录 Catalog

点击目录内容，可直接跳转指定的页面
Click on the directory content to directly jump to the specified page

目录

| | |
|------------------------------------------------------------------|----|
| 目录 Catalog..... | 3 |
| 桐木百叶工艺流程 Paulownia blinds Process..... | 4 |
| 指接叶片的不同 Finger joined slats differences..... | 5 |
| 桐木叶片和封板下轨款式 The style of Paulownia Slats/Valance/Bottom..... | 6 |
| 椴木叶片供应 Basswood supply..... | 10 |
| 竹木叶片供应 Bamboo supply..... | 12 |
| 供应不同材料的叶片长度 The length of different material slats supplied..... | 14 |
| 半成品包装 Blinds component Packing..... | 14 |
| 油漆工艺 Paint process..... | 15 |
| 桐木叶片规格 Specification of Paulownia slats..... | 16 |
| PVC 百叶工艺流程 PVC blinds Process..... | 18 |
| PVC 叶片和封板下轨款式 The style of PVC Slats/Valance/Bottom..... | 19 |
| PVC 车间产能 PVC blinds workshop capacity..... | 23 |
| 货物运输体积 Transport volume..... | 23 |
| 百叶帘系统配件 Blinds system accessory..... | 24 |
| 百叶帘其他配件 Blinds auxiliary accessory..... | 34 |
| 成品包装类型 Packaging type..... | 36 |
| 如何组建百叶帘车间 How to set up blinds workshop..... | 37 |
| 百叶帘款式 Blinds type..... | 39 |
| Find US..... | 41 |

桐木百叶工艺流程 Paulownia blinds Process



1. 桐木林地采料
1. Paulownia wood gardens.



2. 原木原料
2. Raw material.



3. 户外自然晾晒库存
3. Natural dry large stock paulownia wood board.



4. 意大利烘干窑技术烘干原料。
4. The drying in the Italian kiln promotes the redistribution of water in the wood.



5. 烘干后的材料自然养生
5. Post kiln regimen.



6. 木百叶专用多片锯开片
6. Enter the cutting machine for cutting slats.



7. QC 检验木片
7. QC check the raw slats.



8. 确认订单后开始机器砂光
8. Start sanding slats after the order comes in.



9. 手工打磨叶片边部
9. Workers hand sanding for the edge to make sure the edge smooths.



10. 叶片进入喷边房进行喷边
10. Slats enter the paint room, spray edges.

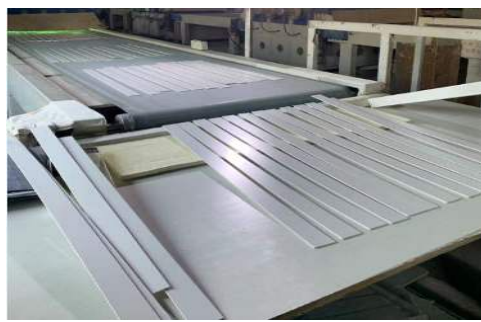

11. 油漆线开始油漆工艺
11. Insert paint line, producing painted.



12. 最终再次进行检验
12. In the final step, workers QC each slat.

指接叶片的不同 Finger joined slats differences



前指接叶片：

前指接指开片前，把方木指接成长料，再进行开片。前指接叶片的宽度和实木叶片宽度一致。指接叶片可以做覆盖色和印刷色，因为有指接印一般不做染色和拉丝，但现在越来越流行用指接叶片做染色效果。







Pre finger jointed slats: Before cutting, connect the square wood with the long material and then cutting into slats. The width of the Pre finger jointed slats is consistent with the width of the solid wood slats. Pre finger jointed slats can be used for painted and printed colors, as finger joint trace generally does not made into stained and brushed colors, but it is increasingly popular to use Pre finger jointed slats made into stained color.

后指接叶片：

后指接指把短的已经开好片的原木素片，指接为单个的长料。后指接叶片宽度会比实木叶片小 1.8mm. 同样，做染色会有指接印记。

Common finger jointed slats: Finger jointed every short raw wood material slats into long slats. The width is smaller than that of solid wood, about 1.8mm .And same,there have finger joint trace can be see on the slats face.

桐木叶片和封板下轨款式 The style of Paulownia Slats/Valance/Bottom

| | | |
|----------------------------|-----------------------------------------------------------------------------------------------------------------------------------------------------------------------------------------------------------------------------------------------|--------------------------------------------------------------------------------------|
| <p>叶片尺寸 Slats Size</p> | <p>叶片尺寸 Slats size: 25mm/35mm/50mm/63mm 实木叶片厚度 Solid wood slats Thickness: 3.0mm 指接叶片厚度 Fingering Slats Thickness: 2.8mm</p>  | |
| <p>颜色效果 Color</p> | <p>覆盖色 Painted / 染色 Stained / 印刷色 Printed / 拉丝 Brushed / 木蜡油色 Decking oil</p> | |
| <p>覆盖色 Painted</p> |  |  |
| <p>染色 Stained</p> |  |  |
| <p>印刷色 Printed</p> |  |  |

拉丝 Brushed

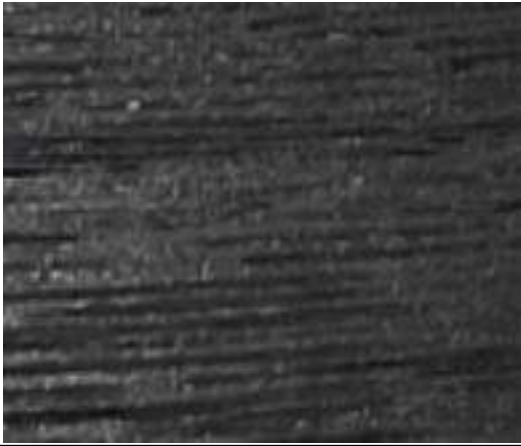

木蜡油色
Decking oil color





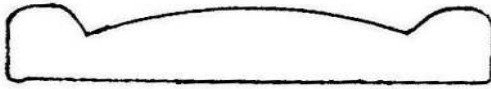



B 封板
B-Valance

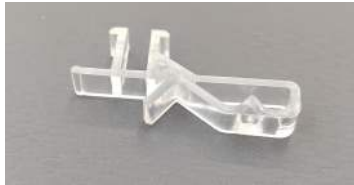

B 封板带槽
B-Valance with slot

B 封板带槽，可以使用塑料封板挂钩。
B-Valance with slot, can used plastic valance clips



| | | |
|---------------------------------------|---------------------------------------------------------------------------------------------------------------------------------------------------------------------|--------------------------------------------------------------------------------------|
| <p>D 封板 D-Valance</p> |  |  |
| <p>D 封板带槽 D-Valance with slot</p> | <p>D 封板带槽，可以使用塑料封板挂钩。 D-Valance with slot, can used plastic valance clips</p>  |  |
| <p>平面封板 Plane-Vanlance</p> |  |  |
| <p>工形下轨 H Bottom</p> |  |  |
| <p>梯形下轨 T Bottom</p> |  |  |

方形下轨
Square Bottom



如果常规的封板和下轨选项没有您想要的款式，我们工厂支持免费开模。

Our factory can customize the type of valance and bottom rail you want, providing you with a free open the mould.





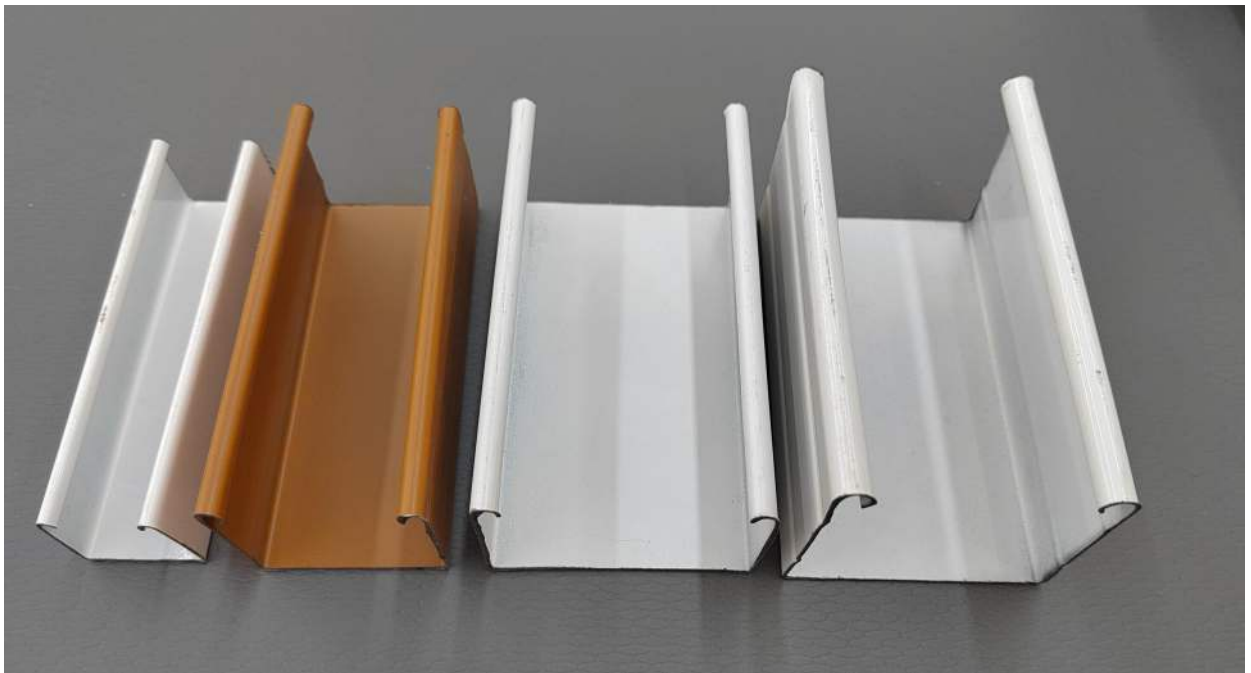

25mm Low rail / 35mm Low rail / 50mm Low rail / 50mm High rail

不锈钢上轨道
Iron Top rail

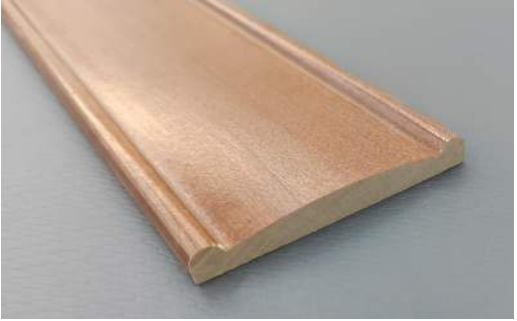
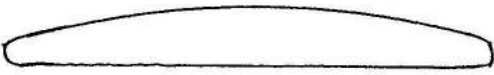







椴木叶片供应 Basswood supply

| | | |
|------------------------------------------------|-------------------------------------------------------------------------------------|-------------------------------------------------------------------------------------------------|
| <p>材料尺寸和厚度 Basswood size and thickness</p> | <p>叶片尺寸 Slats size: 25mm/35mm/50mm/63mm 叶片厚度 Thickness: 2.4mm/2.6mm/2.8mm</p> | <p>我们常规供应 2.8mm 厚度叶片 We usually supply 2.8mm thick slats</p> |
| <p>椴木材料产地 Basswood Producer</p> | <p>我们所有的椴木素材供应来自中国东北 All of our basswood supplies come from Northeast China</p> | <p>可以提供 FSC 椴木 We could supplier FSC basswood</p> |
| <p>椴木材料库存 Basswood Stock</p> |  | <p>3 个月椴木安全库存备货, 300 立方。 3 months of basswood safety stock stocking, 300 m³.</p> |
| <p>椴木色卡 Basswood Color</p> |  | <p>椴木提供覆盖色, 染色, 印刷三种颜色。 Basswood have 3 kinds of color: Painted, Stained, Printed</p> |

| | | |
|-----------------------------------|-------------------------------------------------------------------------------------|---------------------------------------------------------------------------------------|
| <p>B 封板 B-Valance</p> |  |  |
| <p>D 封板 D-Valance</p> |  |  |
| <p>工形下轨 H Bottom</p> |  |  |
| <p>方形下轨 Square Bottom</p> |  |  |

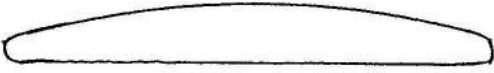
竹木叶片供应 Bamboo supply

| | | |
|----------------------------------------------|-------------------------------------------------------------------------------------|---------------------------------------------------------------------------------------|
| <p>材料尺寸和厚度 Bamboo size and thickness</p> | <p>叶片尺寸 Slats size: 25mm/35mm/50mm/63mm 叶片厚度 Thickness: 3.0mm</p> | <p>竹木特性, 目前只做一种厚度 Bamboo is special, currently only one thickness is produced</p> |
| <p>竹木材料产地 Bamboo Producer</p> | <p>我们所有的椴木素材供应来自中国浙江 All of our bamboo supplies come from Zhejiang, China</p> | <p>可以提供 FSC 竹木 We could supplier FSC bamboo</p> |
| <p>竹木材料库存 Bamboo Stock</p> |  | <p>竹木叶片库存要完全防潮 Bamboo slats are completely moisture-proof</p> |
| <p>竹木色卡 Bamboo color</p> |  | |

| | | |
|-----------------------------------|------------------------------------------------------------------------------------|--------------------------------------------------------------------------------------|
| <p>D 封板 D-Valance</p> |  |  |
| <p>D 封板 D-Valance 2</p> | | |
| <p>方形下轨 Square Bottom</p> |  |  |

供应不同材料的叶片长度 The length of different material slats supplied

1. 桐木叶片 Paulownia Slats:

| | |
|--------------------|-----------------------------------------------|
| 25mm 叶片: 实木 4-7 英尺 | 25mm slats lenght: Solid 4-7ft |
| 35mm 叶片: 实木 5-8 英尺 | 35mm slats lenght: Solid 5-8ft |
| 50mm 叶片: 实木 5-9 英尺 | 50mm slats lenght: Solid 5-9ft |
| 前指接: 最大长度 12 英尺 | Pre finger jointed slats: Max. lenght 12ft |
| 后指接: 最大长度 12 英尺 | Common finger jointed slats: Max. lenght 12ft |



2. 椴木叶片 Basswood slats:

| | |
|--------------------|--------------------------|
| 25mm 叶片: 实木 3-8 英尺 | 25mm slats lenght: 3-8ft |
| 35mm 叶片: 实木 3-8 英尺 | 35mm slats lenght: 3-8ft |
| 50mm 叶片: 实木 3-9 英尺 | 50mm slats lenght: 3-9ft |

3. 竹木叶片 Bamboo slats:

| | |
|------------------|--------------------------|
| 25mm 叶片: 实木 6 英尺 | 25mm slats lenght: 6ft |
| 35mm 叶片: 实木 英尺 | 35mm slats lenght: ft |
| 50mm 叶片: 4-9 英尺 | 50mm slats lenght: 4-9ft |
| 63mm 叶片: 4-8 英尺 | 63mm slats lenght: 4-8ft |

半成品包装 Blinds component Packing

| 包装规格 Packaging Standards | | |
|--------------------------|------------------------|-------------------------|
| 叶片 Slats | 150pcs / carton | |
| 封板 Valance | 30pcs / carton | |
| 下轨 Bottom | 30pcs / carton | |
| 上轨 Top rail | 1pcs/Bag ,20pcs/carton | High rail 12 pcs/carton |



油漆工艺 Paint process

1 白色和黑色的油漆工艺步骤 White/Black slats Painting process steps:

白/黑: 素片→1 遍涂腻子(封闭桐木毛细孔)→喷边→砂光→附着底→3 遍 UV 底漆→UV 面漆

White/Black :Raw slats→Seal coating once →Painting both side of slats→Machine sanding→Adhesion paint→UV paint 3 times
→UV Finish paint once

2 印刷/覆盖色: 油漆工艺步骤 Printed/Painted Color slats Painting process steps:

素片→补腻子→喷边→砂光→NC 白底 x3-4→UV 底 →UV 面(印刷色是 UV 面纹路, 覆盖色是 UV 清面)

Raw slats→Seal coating once →Painting both side of slats→Machine sanding→NC paint 3 times→UV paint→UV Finish paint

3 染色 Stained Color

素片→喷边→砂光→着色→UV 底 →UV 面

Raw slats →Painting both side of slats →Machine sanding→Stained Slats →UV paint→UV Finish paint

4 拉丝 Brushed Color

素片→喷边→拉丝→砂光→UV 底(白色才加这个工艺, 防泛黄) NC 白底 x3-4 →UV 面漆

Raw slats →Painting both side of slats →Brush slats →Machine sanding→UV paint (just white color need) →NC paint 3 times→UV Finish paint

桐木叶片规格 Specification of Paulownia slats

| No. | 项目 Item | 实木标准 Solid slats standard | 指接标准 Normal jointed slats standard | 误差 Tolerance |
|-----|--------------------------------------|---------------------------------------------------------------------------------------------------------------------------------|---------------------------------------------------------------------------------------------------------------------------------|---------------------------------------------------------------------------------------|
| 1 | 材质 Material | 桐木 Paulownia | 桐木 Paulownia | |
| 2 | 结构 Structure | 实木 Solid wood | 指接 Finger jointed | |
| 3 | 宽度 Width | 50.8mm | 49.0mm | ± 0.5mm |
| 4 | 厚度 Thickness | 3.0mm | 2.85mm | ± 0.2mm |
| 5 | 长度 Length | 3ft - 8ft | 6ft-12ft | |
| 6 | 含水量 Moisture content | <10% | <10% | |
| 7 | 侧弯 Camber (for length <4ft) | < 3.2mm | < 3.2mm | |
| | 侧弯 Camber (for 4ft <= length < 7ft) | < 5.6mm | < 5.6mm | |
| | 侧弯 Camber (for 7ft <= length <= 8ft) | <= 6.3mm | <= 6.3mm | |
| | 侧弯 Camber (for 8ft < length <= 12ft) | Solid slats most length 9ft | <= 9.6mm | |
| 8 | 面弯曲 Bow (for length <4ft) | < 2.4mm | < 2.4mm | |
| | 面弯曲 Bow (for 4ft <= length < 7ft) | <4.2mm 少于 | <4.2mm 少于 | |
| | 面弯曲 Bow (for 7ft <= length <= 8ft) | <= 4.8mm | <= 4.8mm | |
| | 面弯曲 Bow (for 8ft < length <= 12ft) | Solid slats most length 9ft | <= 7.2mm | |
| 9 | 测量方法 Measuring method | 在玻璃桌面以 45 度角测量 To be measured by 45-degree angle on glass table | 在玻璃桌面以 45 度角测量 To be measured by 45-degree angle on glass table |  |
| 10 | 外观 Appearance | 木纹不平整是正常, 但其他划痕、凹痕和凹痕不可接受。 Unevenness by wood grain is acceptable but other scratches, damages and dents are not acceptable. | 木纹不平整是正常, 但其他划痕、凹痕和凹痕不可接受。 Unevenness by wood grain is acceptable but other scratches, damages and dents are not acceptable. | |
| 11 | 木材特性 Characteristics of wood | 无死结 No die knots | 无死结 No die knots | |
| 12 | 颜色 Color | 复制颜色需要客户确认 Color copy need confirm by customers | 复制颜色需要客户确认 Color copy need confirm by customers | |
| 13 | 亮度 Gloss | 15 degrees | 15 degrees | ± 5 degrees |

| | | | | |
|----|-----------------------------------------------------------------------------------------------------------------------------------------|----------------------------------------------------------------------------------------------------------------------------------------------------------------------------------------------------------------------------------------------------------------------------------------------------------------------------------------------------------|---------------------------------------------------------------------------------------------------------------------------------------------------------------------------------------------------------------------------------------------------------------------------------------------------------------------------------------------------------------------------------------------------------------------------------------------------------------------------------------------------------|--|
| 14 | 包装 Packing | 150 片/箱 150pcs/carton | 150 片/箱 150pcs/carton | |
| 15 | 木材级别 Wood grade | 根据不同颜色不同档次， 颜色越深档次越低 Based on different color different grade, colors darker grade lower | 根据不同颜色不同档次， 颜色越深档次越低 Based on different color different grade, colors darker grade lower | |
| 16 | 交货期 Lead time | 货物通常在订单确认和定 金收到后 30 天内完成生产 (一个 20 英尺的集装箱接 受 4 种颜色，一个 40 英尺 的集装箱内接受 6 种颜色， 下订单后再次确认详细日 期) Goods usual be finished production in less than 30 days after order confirmed and deposit arrived (4 colors in one 20ft container, 6 colors in one 40ft container, detail date confirmed again once order placed) | 货物通常在订单确认和定 金收到后 35 天内完成生 产 (一个 20 英尺的集装 箱接受 4 种颜色，一个 40 英尺的集装箱接受 6 种颜 色，下订单后再次确认详 细日期，12 英尺的长度最 好不超过 10000 个长度， 叶片越长交货期越久。 Goods usual be finished production in less than 35 days after order confirmed and deposit arrived (4 colors in one 20ft container, 6 colors in one 40ft container, detail date confirmed again once order placed, 12ft length better no more than 10,000 lengths, longer slats more delivery time longer) | |
| 17 | 不良品率 Defect rate | <= 5% | <= 6% | |
| 18 | 叶片重量/米 Weight of per meter for slats | 覆盖色 47g/m Painted color: 47g/m | 覆盖色 47g/m Painted color: 47g/m | |
| | | 染色 44g/m Stain color: 44g/m | 拉丝 40g/m Brushed effected color: 40g/m | |
| 19 | 下轨重量/米 Weight of per meter for bottom rail  | 工形/H-shape 245g/m | 工形/H-shape 245g/m | |
| | | 平面/Plane 260g/m | 平面/Plane 260g/m | |
| | | T 形/T shape 220g/m | T 形/T shape 220g/m | |
| 20 | 封板重量/米 Weight of per meter for valance | 63.5*6.5 B 型封板 135g/m B shape 220g/m | 63.5*6.5 B 型封板 135g/m B shape 220g/m | |
| | | 70*10 封板 215g/m 70*10 valance 215g/m | 70*10 封板 215g/m 70*10 valance 215g/m | |

PVC 百叶工艺流程 PVC blinds Process



PVC 叶片粉末芯料
Powder Core materials



自主生产颗粒面料
Granular surface raw material made by self



自造颗粒色料
Color material made by self



PVC 混料车间
Material mixing workshop



车间挤出线
Extrusion line workshop



共挤技术
Co extrusion technology



实心空心都可以生产
Both solid and hollow can be extruded







检验
QC

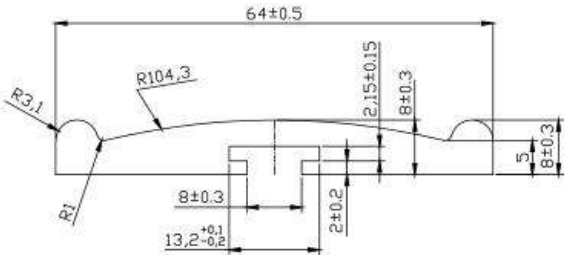

半成品塑料膜包装
Packaging of semi-finished products

PVC 叶片和封板下轨款式 The style of PVC Slats/Valance/Bottom

| | |
|----------------------------|-------------------------------------------------------------------------------------------------------------------------------------------------------------------------------------------------------------------------------------------------|
| <p>叶片尺寸 Slats Size</p> | <p>叶片尺寸 Slats size: 25mm/35mm/50mm/63mm 叶片重量 Slats weight: 70g/80g/90g (常用 90g Regular 90)</p>  |
| <p>颜色效果 Color</p> | <p>纯色 Solid color /印刷色 Printed/印刷色 Printed/压纹 Embossing</p> |
| <p>色卡 Color Car</p> |  |
| <p>B 封板 B-Valance</p> | <p>可以做纯色, 不建议做印刷色 Can made solid color ,not made printed color</p>   |

实心工形下轨
H Bottom

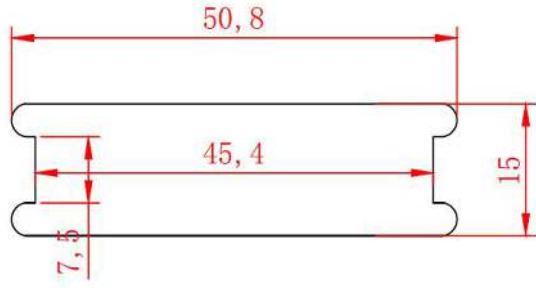

空心工形下轨
Hollow-H Bottom

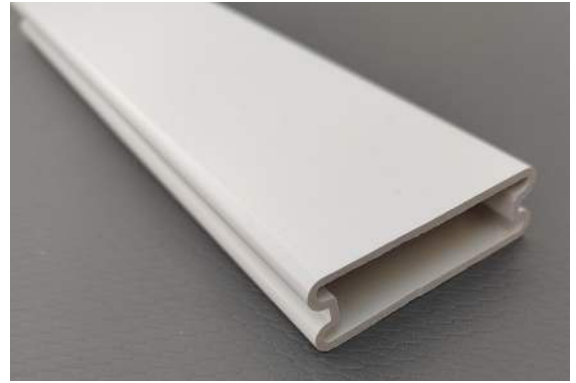

梯形下轨
T Bottom

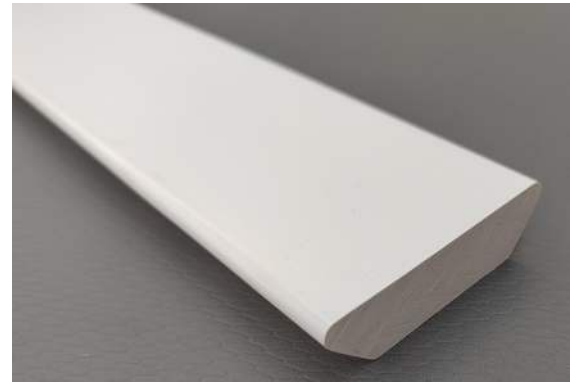
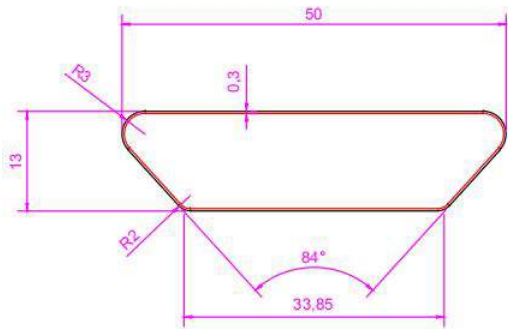

空心梯形下轨
Hollow T Bottom

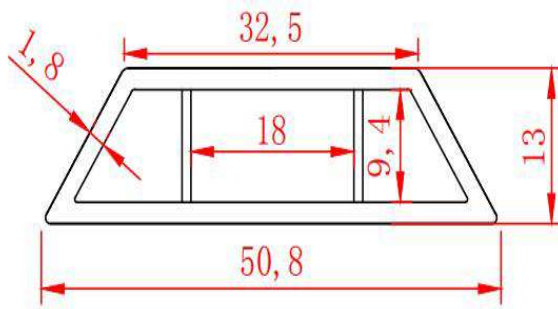

空心梯形下轨 2
Hollow T Bottom 2

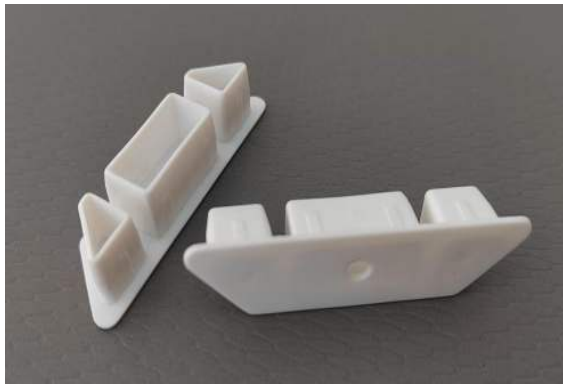

PVC 挤出上轨道
PVC Top rail

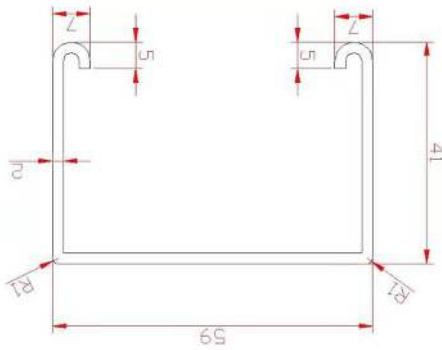

PVC 上轨+铁内衬
PVC Top rail+Iron lining

铁内衬材质是铁，厚度 0.35mm
Material: Iron, Thickness 0.35mm



PVC 转棒
PVC wand

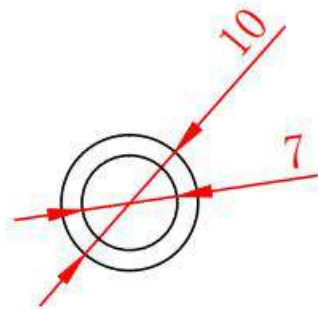

半成品包装(内部裹塑料膜)
Packing (Internally wrapped with plastic film)



PVC 车间产能 PVC blinds workshop capacity

叶片生产线 18 条， 一台机器一天一夜挤出 5500 米叶片

Slats extrusion line: 18, 1 extrusion line can made 5500 meters every 24 hours

封板下轨上轨等 12 条,每 24 小时可以生产下轨 1200 米 /封板 1300 米 /上轨 1300 米, 灰色跟其他带颜色的稍微慢一些。

Valance and top rail extrusion line: 5, 1 extrusion line can made 1200 meters bottom rail /valance 1300m/top rail 1300m

共计 30 条生产线

Extrusion line : Total 30

货物运输体积 Transport volume

成品 Finished product

大柜成品: 约 3500 支 40GP : 3500pcs

小柜成品: 约 1600 支 20GP : 1600pcs

半成品 Semi-finished productsBlinds (Slats,Bottom,Rail)

大柜: 295000 米 40GP :295000m

小柜半品: 145000 米 20GP :145000m

百叶帘系统配件 Blinds system accessory

● 25 拉绳系统 25mm system



固定座
String roll base



固定器
String roll



船型锁具
Cord lock



转棒式 OM
Tiltor for wood wand blinds



25 系统没有铁 OM
25mm No Iron OM



半圆形铁条 2.7*3.7mm
Bar iron 2.7*3.7mm



25 蜘蛛托架
25mm Metal bracket



封套
Box bracket

25 系统幅宽较小时, 可以选择 OM 和锁具在一面
When the system width is small, OM and locks can be selected on one side

● 35 拉绳系统 35mm system

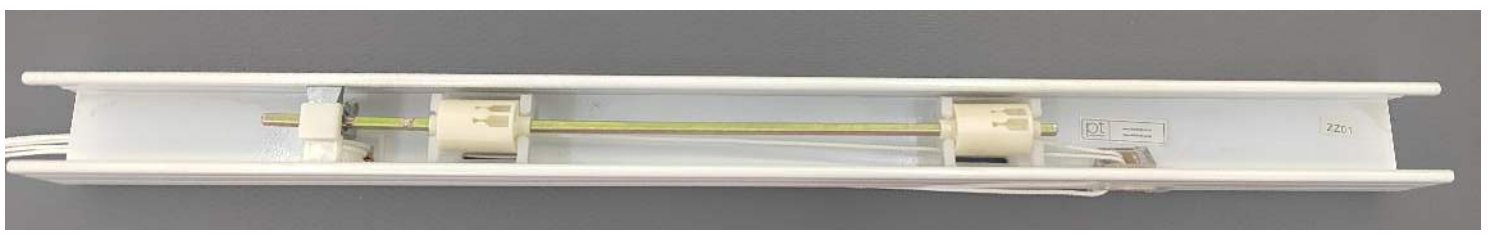

固定座
String roll base

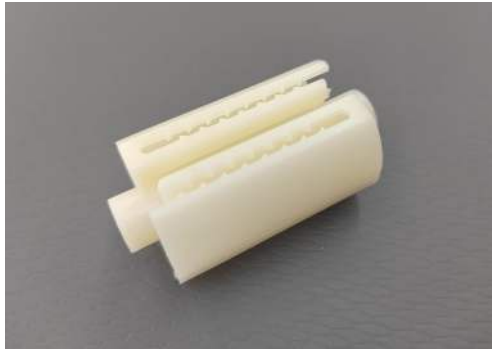

固定器
String roll



船型锁具
Cord lock

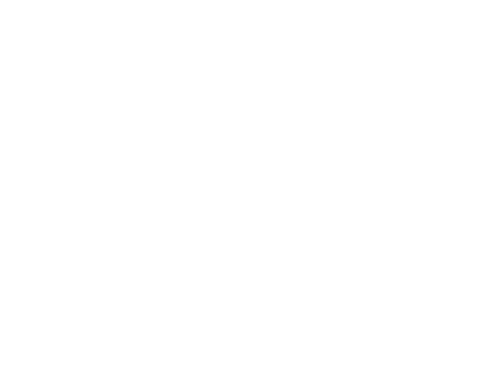

35mm 不做转棒
35mm No wand system



35 系统 OM
35mm OM

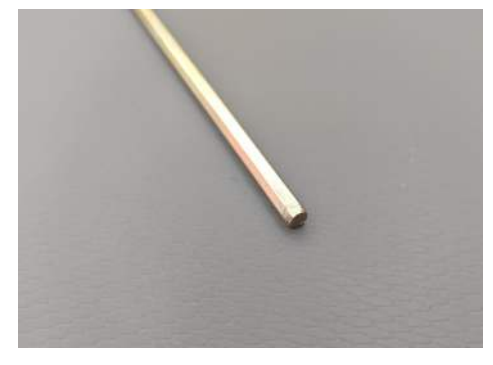

六角铁条
Hexagonal Bar iron



蜘蛛托架
35mm Metal bracket

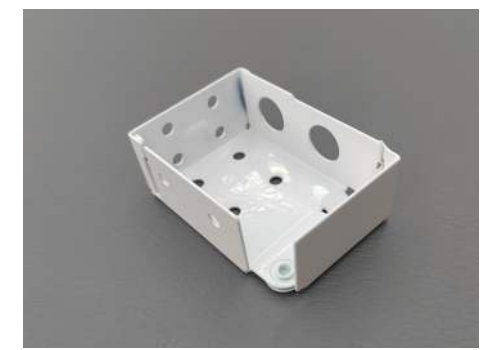

封套
Box bracket

● 50 低轨系统 50mm Low headrail system



固定座
String roll base



固定器
String roll



船型锁具
Cord lock

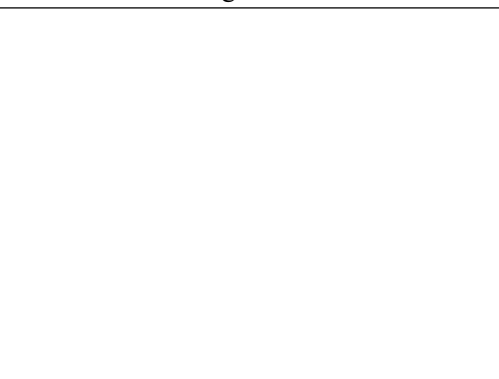

35mm 不做转棒
35mm No wand system

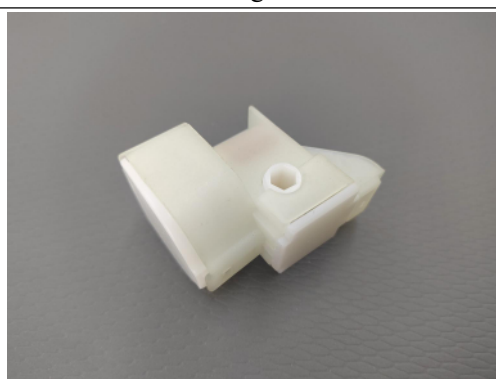

50mm OM



六角铁条
Hexagonal Bar iron



蜘蛛托架
50mm Metal bracket



封套
Box bracket



● 50 高轨系统 50mm High headrail system

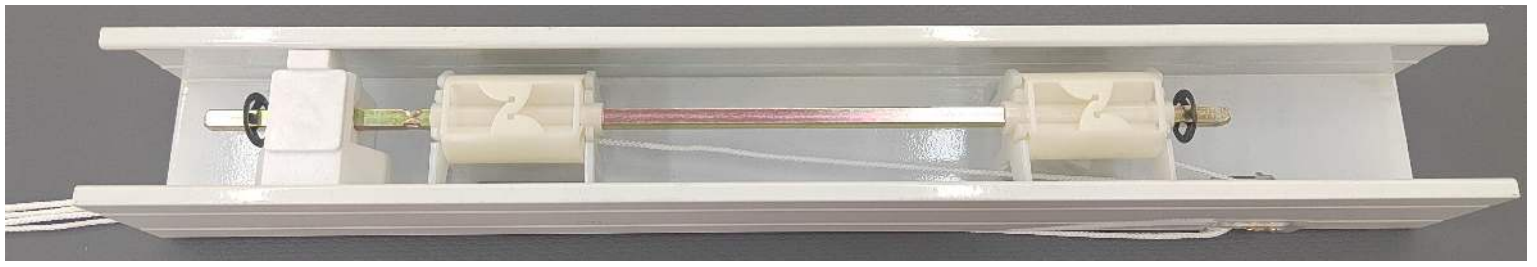

固定座
String roll base

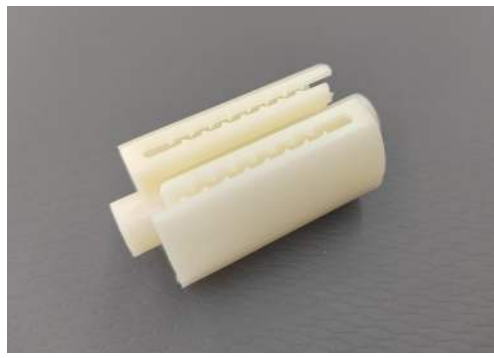

固定器
String roll



船型锁具
Cord lock

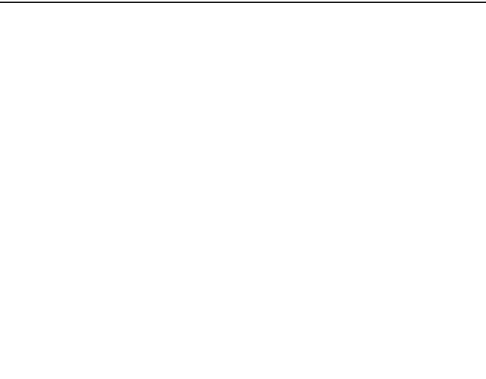

35mm 不做转棒
35mm No wand system

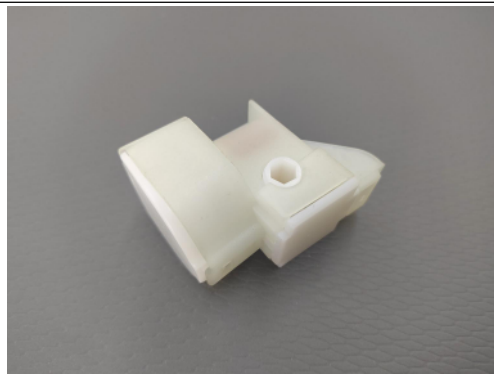

50mm OM

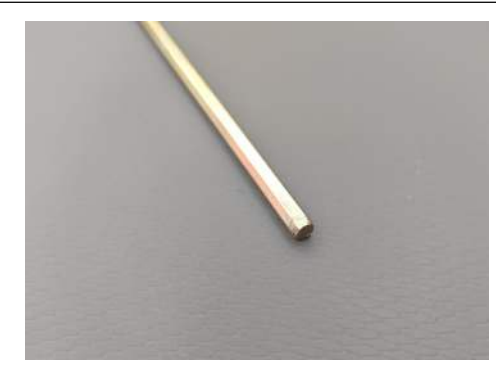

六角铁条
Hexagonal Bar iron



高轨蜘蛛托架
50mm High rail Metal bracket

● 无拉系统 Cordless system

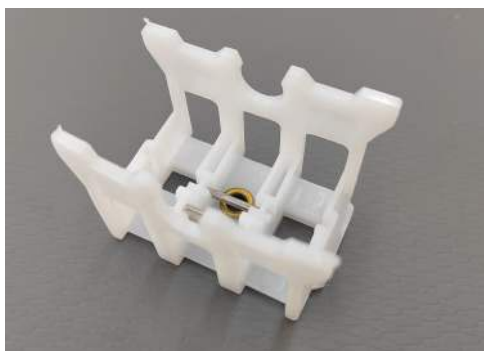

固定座
String roll base



固定器
String roll



六角铁条
Hexagonal Bar iron

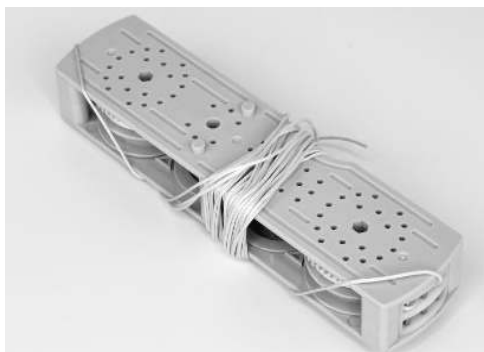

EF 机构盒
EF Module

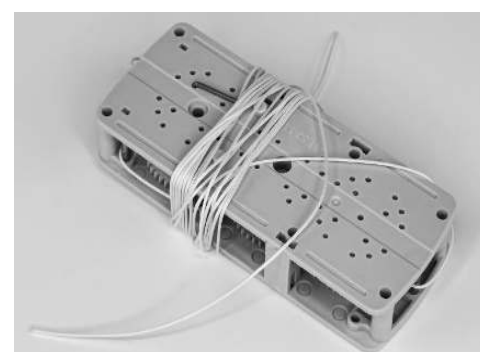

ES 机构盒
ES Module

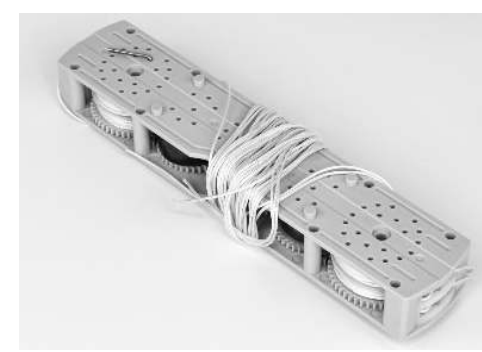

EW 机构盒
EW Module



PVC 转棒式 OM
Tiltor for PVC wand blinds



机构盒固定器
Module holder



C 型扣
Rod Stopper

● 弹簧马达参数表 Module parameter

ES 马达应用规格表 ES Module parameter

| 序号 No | 编号 No | | 组成 Structure | 应用范围 Scope of use | | 说明 Notes |
|-------|---------------|--|--------------------------------------|--------------------|--------------------|----------|
| | 双线 2 wires | | | 最小承重 Min load (kg) | 最大承重 Max load (kg) | |
| 1 | ES2-11-72 | | T=0.11mm, 单簧片 Single spring plate | 0.16 | 2 | |
| 2 | ES2-12-72 | | T=0.12mm, 单簧片 Single spring plate | 0.14 | 2.5 | |
| 3 | ES2-13-72 | | T=0.13mm, 单簧片 Single spring plate | 0.18 | 2.7 | |
| 4 | ES2-15-72 | | T=0.15mm, 单簧片 Single spring plate | 0.25 | 3.3 | |
| 5 | ES2-16-72 | | T=0.16mm, 单簧片 Single spring plate | 0.33 | 3.8 | |
| 6 | ES2-15-72X | | T=0.15mm, 单簧片 Single spring plate | 0.2 | 4.2 | |

EF 马达应用规格表 EF Module parameter

| 序号 No | 编号 No | | | 应用范围 Scope of use | | 说明 Notes |
|----------|------------|------------|--------------------------------------|--------------------|--------------------|-------------------------------------------------------------------------|
| | 双线 2 wires | 四线 4 wires | 组成 Structure | 最小承重 Min load (kg) | 最大承重 Max load (kg) | |
| 1 | EF2-11-96 | EF4-11-96 | T=0.11mm, 单簧片 Single spring plate | 0.14 | 1.85 | 特殊情况下 可以配置三 线 specially , 3 wires can be provided |
| 2 | EF2-12-96 | EF4-12-96 | T=0.12mm, 单簧片 Single spring plate | 0.17 | 2.4 | |
| 3 | EF2-13-96 | EF4-13-96 | T=0.13mm, 单簧片 Single spring plate | 0.2 | 2.7 | |
| 4 | EF2-15-96 | EF4-15-96 | T=0.15mm, 单簧片 Single spring plate | 0.28 | 3.2 | |
| 5 | EF2-16-96 | EF4-16-96 | T=0.16mm, 单簧片 Single spring plate | 0.33 | 3.6 | |
| 6 | EF2-11-96X | EF4-11-96X | T=0.11mm, 单簧片 Single spring plate | 0.16 | 2.1 | |
| 7 | EF2-12-96X | EF4-12-96X | T=0.12mm, 单簧片 Single spring plate | 0.16 | 2.7 | |
| 8 | EF2-13-96X | EF4-13-96X | T=0.13mm, 单簧片 Single spring plate | 0.18 | 3 | |
| 9 | EF2-15-96X | EF4-15-96X | T=0.15mm, 单簧片 Single spring plate | 0.25 | 3.5 | |
| 10 | EF2-16-96X | EF4-16-96X | T=0.16mm, 单簧片 Single spring plate | 0.33 | 4 | |

EW 马达应用规格表 EW Module parameter

| 序号 No | 编号 No | | | 应用范围 Scope of use | | |
|-------|------------|------------|---------------------------------|--------------------|--------------------|----------------------------------------------------------------------|
| | 双线 2 wires | 四线 4 wires | 组成 Structure | 最小承重 Min load (kg) | 最大承重 Max load (kg) | 说明 Notes |
| 1 | EW2-11-96 | EW4-11-96 | T=0.15mm, 双簧片 2 spring plate | 0.32 | 4 | 特殊情况下 可以配置三 线 specially , 3 wires can be provided |
| 2 | EW2-12-96 | EW4-12-96 | T=0.15mm, 双簧片 2 spring plate | 0.4 | 4.5 | |
| 3 | EW2-13-96 | EW4-13-96 | T=0.13mm, 双簧片 2 spring plate | 0.48 | 5 | |
| 4 | EW2-15-96 | EW4-15-96 | T=0.15mm, 双簧片 2 spring plate | 0.66 | 5.9 | |
| 5 | EW2-16-84 | EW4-16-84 | T=0.16mm, 双簧片 2 spring plate | 0.8 | 7 | |
| 6 | EW2-11-96X | EW4-11-96X | T=0.15mm, 双簧片 2 spring plate | 0.28 | 4.1 | |
| 7 | EW2-12-96X | EW4-12-96X | T=0.15mm, 双簧片 2 spring plate | 0.35 | 5 | |
| 8 | EW2-13-96X | EW4-13-96X | T=0.13mm, 双簧片 2 spring plate | 0.45 | 5.6 | |
| 9 | EW2-15-96X | EW4-15-96X | T=0.15mm, 双簧片 2 spring plate | 0.55 | 6.4 | |
| 10 | EW2-16-84X | EW4-16-84X | T=0.16mm, 双簧片 2 spring plate | 0.75 | 7.6 | |

1 一般下梁的重量不能小于最小承重，叶片或面料加下梁的重量一般小于最大承重。

Bottom rail weight > Min Load , All Slats +Bottom weight < Max Load

2 无拉系统的高度一般控制在 72 英寸，及 183cm 的高度，特殊情况可以订制 96 英寸。

Cordless blinds height not more than 183cm. Specially, 243cm height is OK.

3 为了保证受力平衡或叶片不弯曲，一般宽度 40cm 有一条拉绳，根据面料或叶片的宽度选用合适的马达。

In order to ensure force balance or prevent the slats from bending, there is usually a rope with a width of 40cm, and a suitable motor is selected according to the width of the blinds.

4 本马达可应用在 2 英寸无拉百叶、无拉竹罗马帘，分别与不同的配套配件组合使用。

This motor can be applied to 2-inch non pull blinds and non pull bamboo, Roman blinds, and can be combined with different matching accessories.

5 本马达采用优质 POM 材料制作，采用不锈钢弹簧片，寿命超过 5000 次。

This motor is made of high-quality POM material and uses stainless steel spring plates, with a lifespan of over 5000 times.

● 循环拉绳系统 Loop cord blinds headrail system

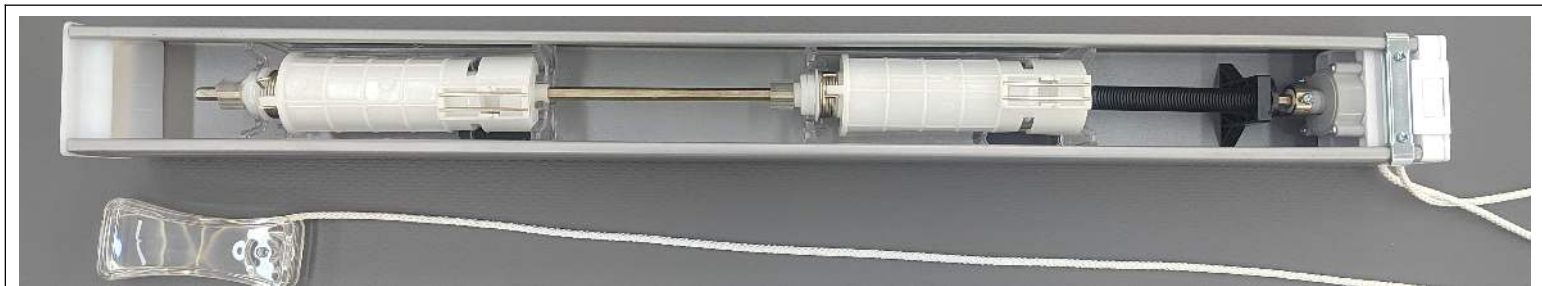

卷绳器



限位器



4角孔制头



四角铁条
Quadrangle Bar iron



C型扣
Rod Stopper



透明手柄
Transparent handle

白色手柄
White handle

拉绳
Cord

拉珠
Bead rope

● 电动系统 Motor system



杜亚电机
DOOYA Motor



奥科电机
A-KO Motor



卷绳器



转棒连接器



电机卡座

电动定制帘：定制款的电机可以做到幅宽 2.4 米，垂长可以做到 3 米。再大的垂长可以做，但是在窗帘下降的时候在 3 米以上的区间会有断断续续的停留，因为超过 3 米的垂长的绳子是卷在第一圈绳子的上面。超过 3 米的不参与质保。

Customized motor blinds: The customized motor can achieve a width of 2.4 meters and a vertical length of 3 meters. No matter how long the drape is, it can be done, but there will be intermittent stops in the range of more than 3 meters when the blinds is descending, because the rope with a drape length of more than 3 meters is coiled on top of the first circle of rope. Items exceeding 3 meters are not covered by warranty.

● 插片式上轨系统 Valance free high headrail system

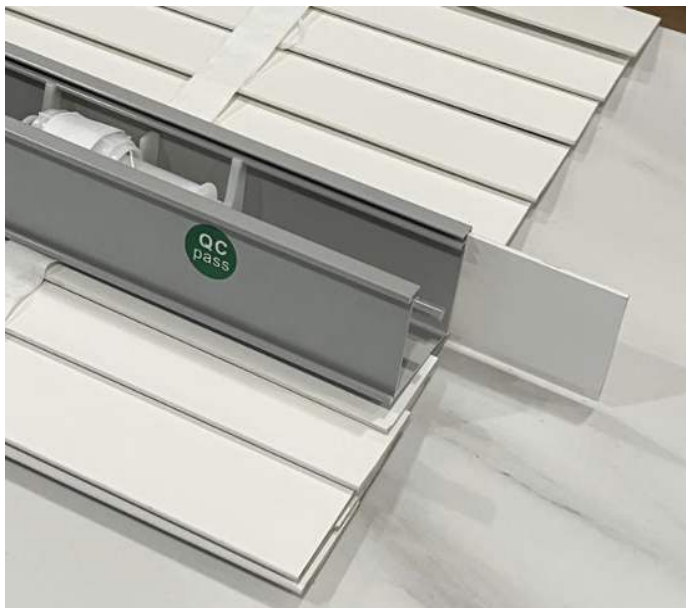

百叶帘其他配件 Blinds auxiliary accessory

| | | |
|-------------------------------------------------------------------------------------|-------------------------------------------------------------------------------------|---------------------------------------------------------------------------------------|
|  |  |  |
| <p>封板挂钩 valance clips</p> | <p>封板挂钩 valance clips</p> | <p>磁吸封板挂钩 Magnet valance clips</p> |
|  |  |  |
| <p>两段式封板挂钩 2 parts valance clips</p> | <p>皇冠封板挂钩 Valance clip for Crown Valance</p> | <p>封板转角连接器</p> |
|  |  |  |
| <p>封板转角连接器 Valance return connector</p> | <p>单孔单牛角 Single Cord Cleats</p> | <p>单孔双牛角 Cord cleats</p> |
|  |  |  |
| <p>叶片夹 Slats Clip</p> | <p>三角片 Hold Down brackets</p> | <p>PVC 下扣 PVC Bottom Rail end cap</p> |

| | | |
|----------------------------------------------------------------------------------|-----------------------------------------------------------------------------------|------------------------------------------------------------------------------------|
|  |  |  |
| <p>省力下扣 Labor saving end cap</p> | <p>宽布梯带下扣 Big wooden button for ladder tape</p> | <p>普通梯带下扣 Empty wooden button for ladder string</p> |
|  |  |  |
| <p>木拉环 Wood tassel</p> | <p>塑料拉环 Plastic tassel</p> | <p>拉绳分离器 Cord release device</p> |
| | | |
| | | |
| | | |
| | | |

成品包装类型 Packaging type



吸塑包装
Blister Packaging

抽屉盒包装
Drawer box packing



彩盒包装
Colour Box packing



PET 盒包装
PET Box packing

如何组建百叶帘车间 How to set up blinds workshop

What you think the difficult actually is very simple! !

Slats, valance and bottom rails
Cutting machine (Four
processes require only 1
worker)

Slats punching machine



Bottom rail holes drilling
machine

Valance metre machine

Headrail cutting machine
+ Head rail punching
machine (Only 1 worker)

Assemble blinds headrail
(1 worker)



The machine for staple
lead to string (1 worker)

Assemble the blinds
need 2 or 3 workers, 1
worker can assemble 30
blinds one day

So set up your workshop total need about 4+3+1+2=10 workers! !
 It only takes 500 M² to set up your production and stock workshop!



QC (1 worker)

Packing need 2 workers

Blinds material inventory storage area

Taiwan fully automatic punching slats,
 about \$20,188



Basswood material is hard,
 and we use punching knife
 with rake cut 62 degree.



Pualownia slats material is relatively
 light and soft compared to basswood,
 so used the punching knife with rake
 20 degree.

百叶帘款式 Blinds type

裁切帘 Cut down blinds

裁切百叶帘是批量生产的百叶帘，梯子留有固定长度，客户可以从末端切割宽度，并重新调整叶片，以达到需要的百叶帘的高度，可以在自己的工厂或工厂使用一台切割机定制尺寸。Cut down blinds are mass produced blinds with ladders left to fixed length, customers can cut the width from the ends and restring the slats to request height of the blinds for custom made sizes in their own factories or facilities with one cut down machine.

可生产材质：桐木/椴木/竹木/PVC

Support Material: Paulownia/Basswood/Bamboo/PVC



成品百叶帘 Ready made blinds

可生产材质：桐木/椴木/竹木/PVC

Support Material: Paulownia/Basswood/Bamboo/PVC

系统 System:

桐木：拉绳，无拉，循环，电动，

Paulownia:Cord/cordless/Loop cord blinds/Motor

椴木：拉绳

Basswood:Cord

竹木：拉绳

Bamboo:Cord

PVC：拉绳，无拉，

PVC: Cord /Cordless

叶片 Slats:

25mm/35mm/50mm/63mm



定制百叶帘 Custom made blinds

我们的定制百叶窗样品盒包括 26 种定制颜色。
不同类型的帷幔和底部栏杆，以及与颜色匹配的梯带。

认证：FSC，ISO，SGS。

系统：传统/链式/电动

材料：桐木/PVC。

叶片：50mm、63mm

叶片油漆：UV

颜色：桐木 26 色，PVC 5 色。

MOQ:1

交付时间：3-7 天

包装：标准邮购包装

Our custom blinds sample box includes 26 custom colors.

Different types of valance and bottom rails, and a ladder tape that matches the color.

Certificata:FSC,ISO,SGS.

System: Traditional/ Chain Mechanism/ Motorised

Material:Paulownia/PVC

Slats:50mm,63mm

Paint for wood slats:UV

Color:26 color for wooden blinds,5 color for faux wood blinds.

MOQ:1

Leading time: 3-7 days

Packing: Standard mail order packing



垂直百叶帘 Wooden vertical blinds

桐木垂直帘

半成品叶片支持颜色定制

起定量 500m/色

叶片类型：指接

Paulownia vertical curtain

Semi finished blades support color customization

MOQ: 500m/color

Blade type: finger joint



Find US

Blinds website: www.blinds-supplier.com

Shutter website: www.shutter-suppliers.com

Shade website: www.shadesupplier.com

Total website address: www.huashengindustry.com



If you click to view our website and social media, you are becoming increasingly interested in us, we greatly welcome you to visit our factory at any time !

Please check our factory address: No.8 industry zone Zhuangzhai Town Heze City Shandong Province, China Fax: 86-0530-6219565